

KENWOOD

AUDIO VIDEO SURROUND RECEIVER

VR-6060
KRF-V8060D

INSTRUCTION MANUAL

KENWOOD CORPORATION

This instruction manual is for some models. Model availability and features (functions) may differ depending on the country and sales area.

About the supplied remote control

Compared to standard remote controls, the remote control supplied with this receiver has several operation modes. These modes enable the remote control to control other audio/video components. In order to effectively use the remote control it is important to read the operating instructions and obtain a proper understanding of the remote control and how to switch its operation modes (etc.). Using the remote control without completely understanding its design and how to switch the operation modes may result in incorrect operations.

Before applying the power

⚠ Caution : Read this page carefully to ensure safe operation.

Units are designed for operation as follows.

- U.S.A. and Canada AC 120 V only
- Australia AC 240 V only
- China and Russia AC 220 V only
- Other countries AC 110-120 / 220-240 V switchable*

* AC voltage selection

The AC voltage selector switch on the rear panel is set to the voltage that prevails in the area to which the unit is shipped. Before connecting the power cord to your AC outlet, make sure that the setting position of this switch matches your line voltage. If not, it must be set to your voltage in accordance with the following direction.

AC voltage selector switch

Move switch lever to match your line voltage with a small screwdriver or other pointed tool.

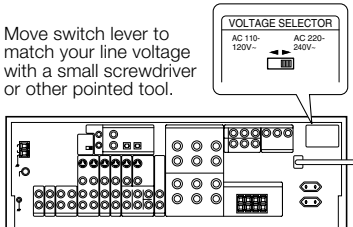





Note:

Our warranty does not cover damage caused by excessive line voltage due to improper setting of the AC voltage selector switch.

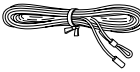
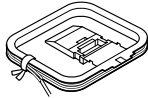
Unpacking

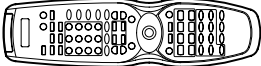
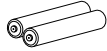
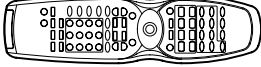
Unpack the unit carefully and make sure that all accessories are present.

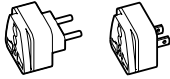
FM indoor antenna (1) 	AM loop antenna (1) 
RF remote antenna (1) (For VR-6060 only) 	
For VR-6060 Remote control unit (1) RC-R0816 	Batteries (R6/AA) (2) 
For KRF-V8060D Remote control unit (1) RC-R0725 	Batteries (R6/AA) (2) 
*AC plug adaptor (2) 	*Use to adapt the plug on the power cord to the shape of the wall outlet. (Accessory only for regions where use is necessary.)

If any accessories are missing, or if the unit is damaged or fails to operate, notify your dealer immediately. If the unit was shipped to you directly, notify your shipper immediately. Kenwood recommends that you retain the original carton and packing materials in case you need to move or ship the unit in the future.

Keep this manual handy for future reference.

Safety precautions

WARNING :

TO PREVENT FIRE OR ELECTRIC SHOCK, DO NOT EXPOSE THIS APPLIANCE TO RAIN OR MOISTURE.



CAUTION
RISK OF ELECTRIC SHOCK
DO NOT OPEN



CAUTION: TO REDUCE THE RISK OF ELECTRIC SHOCK, DO NOT REMOVE COVER (OR BACK). NO USER-SERVICEABLE PARTS INSIDE. REFER SERVICING TO QUALIFIED SERVICE PERSONNEL.



THE LIGHTNING FLASH WITH ARROWHEAD SYMBOL, WITHIN AN EQUILATERAL TRIANGLE, IS INTENDED TO ALERT THE USER TO THE PRESENCE OF UNINSULATED "DANGEROUS VOLTAGE" WITHIN THE PRODUCT'S ENCLOSURE THAT MAY BE OF SUFFICIENT MAGNITUDE TO CONSTITUTE A RISK OF ELECTRIC SHOCK TO PERSONS.



THE EXCLAMATION POINT WITHIN AN EQUILATERAL TRIANGLE IS INTENDED TO ALERT THE USER TO THE PRESENCE OF IMPORTANT OPERATING AND MAINTENANCE (SERVICING) INSTRUCTIONS IN THE LITERATURE ACCOMPANYING THE APPLIANCE.

Maintenance of the unit





When the front panel or case becomes dirty, wipe with a soft, dry cloth. Do not use thinner, benzine, alcohol, etc. for these agents may cause discoloration.

In regard to contact cleaner

Do not use contact cleaners because it could cause a malfunction. Be specially careful not to use contact cleaners containing oil, for they may deform the plastic component.

Contents

Caution : Read the pages marked  carefully to ensure safe operation.

Preparations	 Before applying the power 2
	 Safety precautions 2
	Unpacking 2
	How to use this manual 4
	Special features 4
	Names and functions of parts 5
	Main Unit 5
	Remote control unit (RC-R0816) (VR-6060) 6
	Remote control unit (RC-R0725) (KRF-V8060D) ... 7
	Setting up the system 8
	Connecting audio components 9
	Connecting video components 10
	Digital connections 11
	Connecting video components (COMPONENT VIDEO) 12
	Connecting a DVD player (6-channel input) 13
	Connecting the speakers 14
	Connecting the terminals 15
Connecting to the AV AUX jacks 16	
Connecting the antennas 16	
Connecting the system control 17	
Connecting the RF antenna and external IR Repeater (For VR-6060 only) 18	
Preparing the remote control 19	
RF remote control function (For VR-6060 only) ... 19	
Preparing for surround sound 20	
Speaker settings 20	
Operations	Normal playback 22
	Preparing for playback 22
	Listening to a source component 23
	Adjusting the sound 23
	Recording 25
	Recording audio (analog sources) 25
	Recording video 25
	Recording audio (digital sources) 25
	Listening to radio broadcasts 26
	Tuning radio stations 26
	Presetting radio stations manually 26
	Receiving preset stations 27
Receiving preset stations in order (P.CALL) ... 27	
Ambience effects 28	
Surround modes 28	
Surround play 30	
DVD 6-channel playback 31	
Convenient functions 32	
Remote Control	Basic remote control operations for other components 34
	Registering setup codes for other components 34
	Operating other components 35
	Storing the remote control code of the other components (For VR-6060 only) 35
	Setup code chart (RC-R0816) (VR-6060) and (RC-R0725) (KRF-V8060D) 36
	CASSETTE deck, CD player & MD recorder operations 37
	Other components' operations 38
	Additional Information  In case of difficulty 40
	 Specifications 42

For the U.S.A.

FCC WARNING

This equipment may generate or use radio frequency energy. Changes or modifications to this equipment may cause harmful interference unless the modifications are expressly approved in the instruction manual. The user could lose the authority to operate this equipment if an unauthorized change or modification is made.

NOTE:

This equipment has been tested and found to comply with the limits for a Class B digital device, pursuant to Part 15 of the FCC Rules. These limits are designed to provide reasonable protection against harmful interference in a residential installation. This equipment may cause harmful interference to radio communications, if it is not installed and used in accordance with the instructions. However, there is no guarantee that interference will not occur in a particular installation. If this equipment does cause harmful interference to radio or television reception, which can be determined by turning the equipment off and on, the user is encouraged to try to correct the interference by one or more of the following measures:

- Reorient or relocate the receiving antenna.
- Increase the separation between the equipment and receiver.
- Connect the equipment into an outlet on a circuit different from that to which the receiver is connected.
- Consult the dealer or an experienced radio / TV technician for help.

For the U.S.A.

FCC Compliance Notice

Audio-video Receiver, VR-6060

These devices comply with Part 15 of FCC Rules. Operation is subject to the following two conditions: (1) This device may not cause harmful interference, and (2) this device must accept any interference received, including interference that may cause undesired operation.

KENWOOD U.S.A. CORPORATION

2201 East Dominguez St., Long Beach, CA 90801-5745

Telephone: 310-639-9000

For Canada

IC (Industry Canada) Notice

Operation is subject to the following two conditions: (1) this device may not cause interference, and (2) this device must accept any interference, including interference that may cause undesired operation of the device.

The term "IC:" before the certification/registration number only signifies that the Industry Canada technical specifications were met.

For the U.S.A.

Note to CATV system installer

This reminder is provided to call the CATV system installer's attention to Article 820-40 of the NEC that provides guidelines for proper grounding and, in particular, specifies that the cable ground shall be connected to the grounding system of the building, as close to the point of cable entry as practical.



As an ENERGY STAR® Partner, Kenwood Corporation has determined that this product meets the ENERGY STAR® guidelines for energy efficiency.

This product can save energy. Saving energy reduces air pollution and lowers utility bills.

How to use this manual

This manual is divided into four sections, Preparations, Operations, Remote Control, and Additional Information.

Preparations

Shows you how to connect your audio and video components to the receiver and prepare the surround processor.

Since this receiver works with all your audio and video components, we will guide you in setting up your system to be as easy as possible.

Operations

Shows you how to operate the various functions available on the receiver.

Remote Control

Shows you how to operate other components using the remote control, as well as a detailed explanation of all remote control operations. Once you have registered your components with the proper setup codes, you'll be able to operate both this receiver and your other AV components (TV, VCR, DVD player, CD player, etc.) using the remote control supplied with this receiver.

Additional Information

Shows you additional information such as "In case of difficulty" (trouble-shooting) and "Specifications".

Memory back up function

Please note that the following items will be deleted from the unit's memory if the power cord is disconnected from the AC outlet for approximately 1 day.

- Power mode.
- Input selector settings.
- Picture output.
- Speaker ON/OFF.
- Volume level.
- BASS, TREBLE, INPUT level.
- TONE ON/OFF.
- LOUDNESS ON/OFF.
- Dimmer level.
- MD/TAPE settings.
- RF-BAND. (VR-6060 only)
- Listen mode setting.
- Speaker settings.
- SW RE-MIX ON/OFF.
- Distance setting.
- Input mode setting.
- Midnight mode setting.
- PRO LOGIC II mode setting.
- CS II mode setting.
- Broadcast band.
- Frequency setting.
- Preset stations.
- Tuning mode.
- DSP mode.
- ACTIVE EQ mode.
- SPEAKER EQ mode.

Special features

True home theater sound

This receiver incorporates a wide variety of surround modes to bring you maximum enjoyment from your video software. Select a surround mode according to your equipment or the software you are going to play and enjoy! → 28

Dolby Digital and Dolby Digital EX

The DOLBY DIGITAL mode lets you enjoy full digital surround from software processed in the Dolby Digital format. Dolby Digital provides up to 5.1 channels of independent digital audio for better sound quality and more powerful presence than conventional Dolby Surround.

As for Dolby Digital EX, it creates six full-bandwidth output channels from the 5.1 channel sources. This is done using a matrix decoder that derives three surround channels from the two in the original recording. For best results, Dolby Digital EX should be used with movie soundtracks recorded with Dolby Digital Surround EX.

Dolby PRO LOGIC II

DOLBY PRO LOGIC II, whilst totally compatible with its predecessor PRO LOGIC, provides greater advantages in surround sound. It allows the user to enjoy the conventional stereo or Dolby Surround with a convincing "5.1 like" presentation. PRO LOGIC II offers special features for controlling the overall spatial, dimensionality and frontal sound field imaging. PRO LOGIC II produces an impressive surround sound from video software marked  and three-dimensional space from music CD. When listening to music, you will be able to enjoy the experience of sheer STEREO surround sound.

DTS-ES

The DTS-ES (Digital Theater System-Extended Surround) is a 6.1-channel Discrete Surround format which is extended to DTS-ES Discrete 6.1, DTS-Matrix 6.1 and DTS NEO:6. It is a 6.1 channel expanded from 5.1 surround which includes an additional surround center channel developed within surround left and surround right. DTS-ES will be able to produce the original sound recorded similar to the theatrical effects. In the DTS-ES mode, the 5.1 or 6.1 channel digital input from a DTS CD, LD or DVD disc (carrying the "DTS" or "DTS-ES" marking) can be played in Digital Surround.

Important:

When a DTS disc is played on a CD, LD or DVD player, noise may be output from the analog output. It is recommended that you connect the digital output of the player to the digital input of this unit.

Multi channel surround sound (SRS Circle Surround II (●)CS™)

SRS Circle Surround II™ improves on its predecessor CS-5.1™ resulting in the CS-6.1™ system, enabling you to listen to realistic, multi-channel, surround sound playback from a stereo source or conventional surround-encoded video source. You already enjoy listening to Dolby digital sound/DTS multi-channel sound with your multi-speakers. Now you can listen to audio CDs, MDs, Broadcast and Home Theater using your multi-speakers. You will discover a new type of sound through SRS Circle Surround II.

DSP surround modes

The DSP (Digital Signal Processor) used for this receiver incorporates a variety of high quality adjustable sound fields, like "ARENA", "JAZZ CLUB", "THEATER", "STADIUM" and "DISCO". It is compatible with almost any kind of program source.

DVD 6-channel input

If you own a DVD player equipped with 6-channel output, this receiver allows you to obtain the full surround sound impact of DVD source material featuring multi-channel encoding. Since the source signals are digital and each channel is input independently, the resulting ambience is far superior to what can be achieved with conventional surround sound systems.

ACTIVE EQ

ACTIVE EQ mode will produce a more dynamic sound quality in any condition. You can enjoy a more impressive sound effect when ACTIVE EQ is turned on during Dolby Digital and DTS playback.

SPEAKER EQ

The SPEAKER EQ function will automatically detect the various features of each speaker and effectively creates a stereoscopic sound effect.

Remote control

This remote control has two kinds of signal.

Universal IR (InfraRed) remote control

In addition to the basic receiver, the remote control supplied with this receiver can also operate almost all of your remote controllable audio and video components. Just follow the simple setup procedure to register the components you have connected.

RF remote signal (For VR-6060 only)

You can operate the receiver by sending RF remote signal from the remote control. The controllable range of the remote control is not influenced by surroundings such as distance or an obstruction.

Names and functions of parts

Main unit

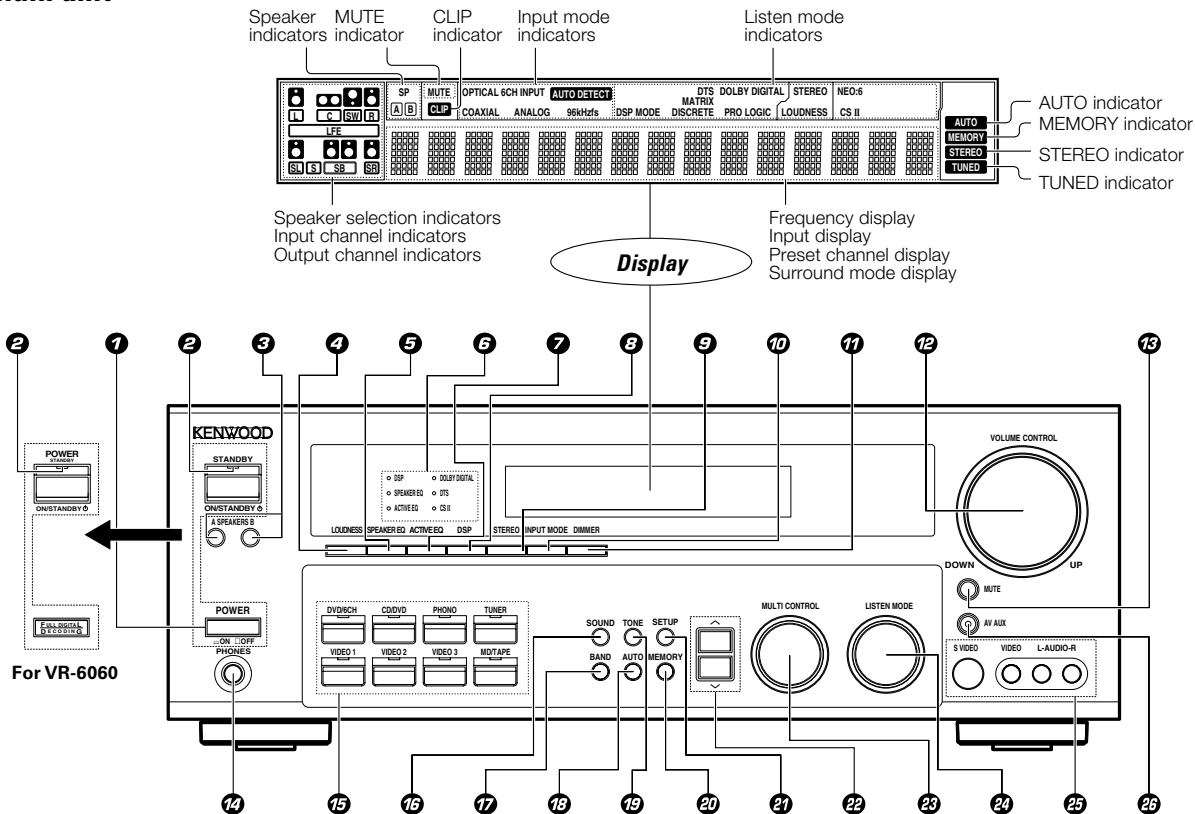

- 1 POWER ON/OFF key** (For KRF-V8060D) - [20]
Use to turn the main power ON/OFF.
- 2 ON/STANDBY (⏻) key** (For KRF-V8060D) - [20]
Use to turn the power ON/STANDBY when the POWER is turned ON.
STANDBY indicator
- 3 POWER ON/STANDBY (⏻) key** (For VR-6060) - [20]
Use to turn the power ON/STANDBY.
STANDBY indicator
- 4 A SPEAKERS B keys** - [22]
Use to turn the A/B speakers ON/OFF.
- 5 LOUDNESS key** - [24]
Use to switch the status of LOUDNESS.
- 6 SPEAKER EQ key** - [24]
Use to select SPEAKER EQ's setting.
- 7 Surround indicators**
DSP indicator - [30]
Lights when the receiver is in the DSP mode.
SPEAKER EQ indicator - [24]
Lights when the receiver is in the SPEAKER EQ mode.
ACTIVE EQ indicator - [24]
Lights when the receiver is in the ACTIVE EQ mode.
DOLBY DIGITAL indicator - [30]
Lights when the receiver is in the Dolby Digital mode.

- 8 DTS indicator** - [30]
Lights when the receiver is in the DTS mode.
- 9 CS II indicator** - [30]
Lights when the receiver is in the CIRCLE SURROUND II mode.
- 10 ACTIVE EQ key** - [24]
Use to select ACTIVE EQ's setting.
- 11 DSP key** - [30]
Use to select any of the DSP mode.
- 12 STEREO key** - [32]
Use to switch the listen mode to STEREO.
- 13 INPUT MODE key** - [8]
Use to switch between the full auto, digital and analog inputs.
- 14 DIMMER key** - [25]
Use to select the REC MODE.
- 15 VOLUME CONTROL knob** - [23]
MUTE key - [24]
Use to temporarily mute the sound.
- 16 PHONES jack** - [24]
Use for headphone listening.
- 18 Input Selector keys** (DVD/6CH, CD/DVD, PHONO, TUNER, VIDEO 1, VIDEO 2, VIDEO 3, MD/TAPE) - [23]
Use to select input sources.
- 19 SOUND key** - [32]
Use to adjust the sound quality and the ambience effects.

- 17 BAND key** - [26]
Use to select the broadcast band.
- 18 AUTO key** - [26]
Use to select the auto or manual tuning mode.
- 19 TONE key** - [23]
Use to switch the status of TONE control.
- 20 MEMORY key** - [26]
Use to store radio stations in the preset memory.
- 21 SETUP key** - [20]
Use to select the speakers' settings etc.
- 22 ^/v keys** - [20]
Use for selection adjustments during SOUND, SETUP and PRESET CHANNEL functions.
- 23 MULTI CONTROL knob** - [20]
Use to control a variety of settings.
- 24 LISTEN MODE knob** - [30]
Use to select the listening mode.
- 25 AV AUX (S VIDEO, VIDEO, AUDIO L/R) jacks** - [16]
- 26 AV AUX key** - [16]
Use to switch the input to AV AUX.

Standby mode

While the standby indicator is lit, a small amount of power is supplied to the system to back up the memory. This is called standby mode. Under the condition, the system can be turned ON by remote control unit.

Connection at POWER ON/OFF key (for KRF-V8060D)

The power in this equipment will not be completely cut off from the AC wall outlet when the main switch is turned OFF.

Remote control unit (RC-R0816) (VR-6060)

This remote control unit can be used not only for Kenwood products but also for other non-Kenwood products by setting the appropriate manufacturer's setup codes. → [36]

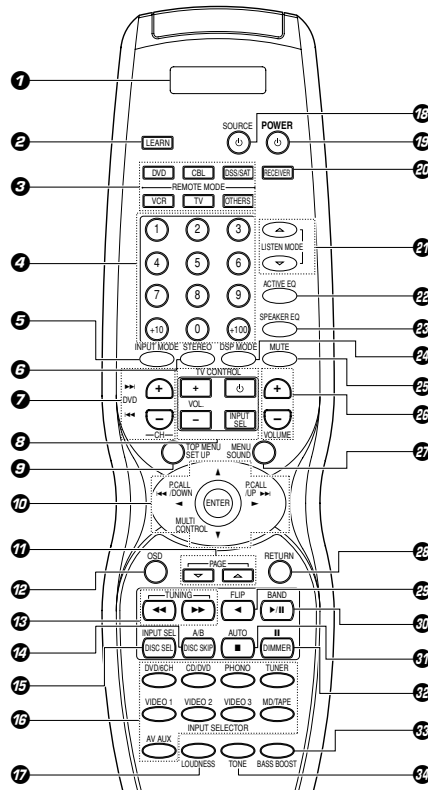

If the name of a function is different on the receiver and on the remote control, the name of the remote control key in this manual is indicated in parentheses.

- 1 LCD (Liquid Crystal Display)**
- 2 LEARN key** → [35]
Use to memorize the operation of the other remote controls.
- 3 REMOTE MODE keys (DVD, CBL, DSS/SAT, VCR, TV, OTHERS)** → [34]
Use to select the components registered at the respective input.
- 4 Numeric keys** → [34]
Provide functions identical to those of the original remote control supplied with the component you are controlling.
- 5 INPUT MODE key** → [8]
Use to switch between the full auto, digital and analog inputs.
- 6 STEREO key** → [32]
Use to switch the listen mode to STEREO.
- 7 CH +/- keys**
Use to select the channels.
▶▶ DVD ◀◀ keys
When in DVD player operations, these keys function as skip keys.
- 8 TV CONTROL keys**
Use when in TV operation.
- 9 TOP MENU key**
Use to operate the DVD component.
SET UP key → [20]
Use to select the speakers' settings etc.
- 10 Joystick ENTER**
Use to operate other components.
MULTI CONTROL ▲/▼ → [20]
Use to control a variety of settings.
Use to operate other components.
P. CALL ◀◀/DOWN ◀ and P. CALL/UP ▶▶
▶ → [27]
Use for selection adjustments during SOUND, SET UP and PRESET channel functions.

- 11 PAGE ▲/▼ key**
Use to operate the DVD component.
- 12 OSD key**
Use to operate the DVD component.
- 13 TUNING ◀◀/▶▶ keys** → [26]
Use to operate the tuner mode.
If CD, MD or TAPE is selected as the input source, these keys function as search keys.
- 14 DISC SKIP key**
If CD is selected as the input source, this key functions as the multi-CD player disc skip key.
A/B key
If TAPE is selected as the input source, this is A and B deck of a double cassette deck.
- 15 DISC SEL key**
Use to operate other components.
INPUT SEL key
Use to operate other components.
- 16 INPUT SELECTOR keys (DVD/6CH, CD/DVD, PHONO, TUNER, VIDEO 1, VIDEO 2, VIDEO 3, MD/TAPE, AV AUX)**
Use to select the input sources. → [23]
- 17 LOUDNESS key** → [24]
Use to switch the status of LOUDNESS.
- 18 SOURCE (⏻) key**
Use to turn the other components ON/OFF.
- 19 POWER (⏻) key** → [20]
Use to turn the receiver ON/OFF.
- 20 RECEIVER key**
Use to return to the operation of the receiver.
- 21 LISTEN MODE ▲/▼ keys** → [30]
Use to select the listening mode.
- 22 ACTIVE EQ key** → [24]
Use to select ACTIVE EQ's setting.
- 23 SPEAKER EQ key** → [24]
Use to select SPEAKER EQ's setting.
- 24 DSP MODE key** → [30]
Use to select any of the DSP mode.

- 25 MUTE key** → [24]
Use to temporarily mute the sound.
- 26 VOLUME +/- keys** → [23]
Use to adjust the receiver volume.
- 27 MENU key**
Use to operate other components.
SOUND key → [32]
Use to adjust the sound quality and the ambience effects.
- 28 RETURN key**
Use to operate other components.
- 29 ◀ key**
Use to operate other components.
FLIP key
Use to operate other components.
- 30 ▶/II key**
If CD is selected as the input source, this key functions as the play/pause key.
If MD or TAPE key is selected as input source, this key functions as the play key.
BAND key → [26]
Use to select the broadcast band.
- 31 ■ key**
If CD, MD, or TAPE is selected as the input source, this key functions as the stop key.
AUTO key → [26]
Use to select the auto or manual tuning mode.
- 32 DIMMER key** → [33]
Use to adjust the brightness of the display.
- II key**
Use to operate other components.
- 33 BASS BOOST key** → [23]
Use to select the maximum adjustment setting for the low frequency range.
- 34 TONE key** → [23]
Use to switch the status of TONE control.

Remote control unit (RC-R0725) (KRF-V8060D)

This remote control unit can be used not only for Kenwood products but also for other non-Kenwood products by setting the appropriate manufacturer's setup codes. → [36]

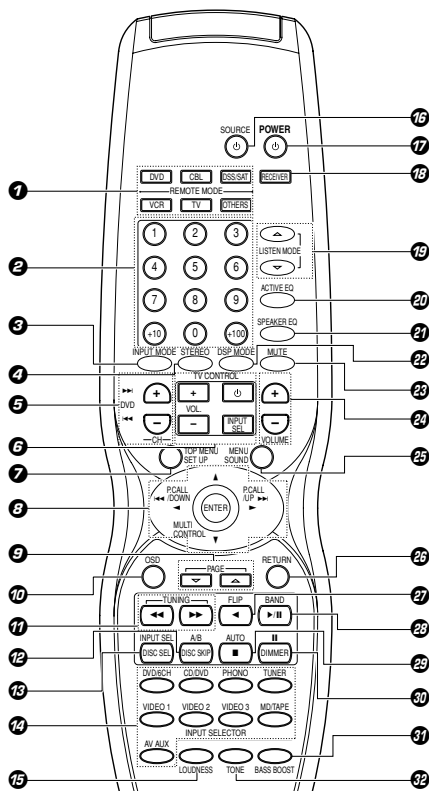

1 REMOTE MODE keys (DVD, CBL, DSS/SAT, VCR, TV, OTHERS) → [34]

Use to select the components registered at the respective input.

2 Numeric keys → [34]

Provide functions identical to those of the original remote control supplied with the component you are controlling.

3 INPUT MODE key → [8]

Use to switch between the full auto, digital and analog inputs.

4 STEREO key → [32]

Use to switch the listen mode to STEREO.

5 CH +/- keys

Use to select the channels.

▶▶ DVD ◀◀ keys

When in DVD player operations, these keys function as skip keys.

6 TV CONTROL keys

Use when in TV operation.

7 TOP MENU key

Use to operate the DVD component.

SET UP key

Use to select the speakers' settings etc. → [20]

8 Joystick

ENTER

Use to operate other components.

MULTI CONTROL ▲/▼

Use to control a variety of settings.

Use to operate other components.

P.CALL ◀◀/DOWN ◀ and P.CALL/UP ▶▶

Use for selection adjustments during SOUND, SET UP and PRESET channel functions. → [27]

9 PAGE ▲/▼ key

Use to operate the DVD component.

10 OSD key

Use to operate the DVD component.

11 TUNING ◀◀/▶▶ keys → [26]

Use to operate the tuner mode.

If CD, MD or TAPE is selected as the input source, these keys function as search keys.

12 DISC SKIP key

If CD is selected as the input source, this key functions as the multi-CD player disc skip key.

A/B key

If TAPE is selected as the input source, this is A and B deck of a double cassette deck.

13 DISC SEL key

Use to operate other components.

INPUT SEL key

Use to operate other components.

14 INPUT SELECTOR keys (DVD/6CH, CD/DVD, PHONO, TUNER, VIDEO 1, VIDEO 2, VIDEO 3, MD/TAPE, AV AUX)

Use to select the input sources. → [23]

15 LOUDNESS key

Use to switch the status of LOUDNESS. → [24]

16 SOURCE (⏻) key

Use to turn the other components ON/OFF. → [20]

17 POWER (⏻) key

Use to turn the receiver ON/OFF. → [20]

18 RECEIVER key

Use to return to the operation of the receiver.

19 LISTEN MODE ▲/▼ keys

Use to select the listening mode. → [30]

20 ACTIVE EQ key

Use to select ACTIVE EQ's setting. → [24]

21 SPEAKER EQ key

Use to select SPEAKER EQ's setting. → [24]

22 DSP MODE key

Use to select any of the DSP MODE. → [30]

23 MUTE key

Use to temporarily mute the sound. → [24]

If the name of a function is different on the receiver and on the remote control, the name of the remote control key in this manual is indicated in parentheses.

24 VOLUME +/- keys → [23]

Use to adjust the receiver volume.

25 MENU key

Use to operate other components.

SOUND key

Use to adjust the sound quality and the ambience effects. → [32]

26 RETURN key

Use to operate other components.

27 ◀ key

Use to operate other components.

FLIP key

Use to operate other components.

28 ▶/II key

If CD is selected as the input source, this key functions as the play/pause key. If MD or TAPE key is selected as input source, this key functions as the play key.

BAND key

Use to select the broadcast band. → [26]

29 ■ key

If CD, MD, or TAPE is selected as the input source, this key functions as the stop key. Use to select the auto or manual tuning mode.

30 DIMMER key

Use to adjust the brightness of the display. → [33]

II key

Use to operate other components.

31 BASS BOOST key

Use to select the maximum adjustment setting for the low frequency range. → [23]

32 TONE key

Use to switch the status of TONE control. → [23]

Setting up the system

Make connections as shown in the following pages. When connecting the related system components, be sure to refer to the instruction manuals supplied with the components you are connecting. Do not connect the power cord to a wall outlet until all connections are completed.

Notes

1. Be sure to insert all connection cords securely. If their connections are imperfect, sound may not be produced or there will be noise inference.
2. Be sure to remove the power cord from the AC outlet before plugging or unplugging any connection cords. Plugging/unplugging connection cords without disconnecting the power cord can cause malfunctions and may damage the unit.
3. Do not connect power cords from components whose power consumption is larger than what is indicated on the AC outlet at the rear of this unit.

Analog connections

Audio connections are made using RCA pin cords. These cables transfer stereo audio signal in an "analog" form. This means the audio signal corresponds to the actual audio of two channels. These cables usually have 2 plugs on each end, one red for the right channel and one white for the left channel. These cables are usually packed together with the source unit, or are available at your local electronics retailer.

Microcomputer malfunction

If operation is not possible or an erroneous display appears, even though all connections have been made properly, reset the microcomputer referring to "In case of difficulty".



CAUTION

Be sure to adhere to the following, or proper ventilation will be blocked causing damage or fire hazard.

- Do not place any objects impairing heat radiation onto the top of the unit.
- Leave some space around the unit (from the largest outside dimension including projection) equal to or greater than, shown below.

Top panel : 50 cm Side panel : 10 cm Back panel : 10 cm

Input mode settings

CD/DVD, VIDEO 2, VIDEO 3 and DVD/6CH inputs each include jacks for digital audio input and analog audio input.

You must select beforehand which type of input is to be used for each connected component.

The initial factory settings for audio signal playback for CD/DVD, DVD/6CH, VIDEO 2 and VIDEO 3 are full auto.

To use the analog audio input for playback instead (if, for example, you have connected a VCR to the VIDEO 2 or VIDEO 3 input), you must set the input mode for the corresponding input to the analog mode.

After completing connections and turning on the receiver, follow the steps below.

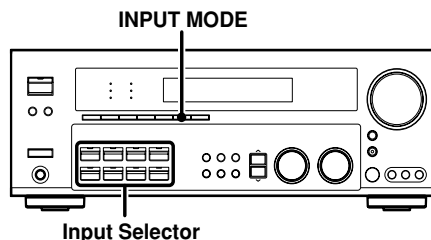

- 1 Use the Input Selector keys to select CD/DVD, VIDEO 2, VIDEO 3 or DVD/6CH.

- 2 Press the INPUT MODE key.

Each press switches the setting as follows:

In DTS play mode

- 1 FULL AUTO (digital input, analog input)
- 2 DIGITAL MANUAL (digital input)

In CD/DVD, VIDEO 2, VIDEO 3 or DVD/6CH play mode

- 1 FULL AUTO (digital input, analog input)
- 2 DIGITAL MANUAL (digital input)
- 3 6CH INPUT (DVD/6CH input)
- 4 ANALOG (analog input)

Digital input:

Select this setting to play digital signals from a DVD, CD, or LD player.

Analog input:

Select this setting to play analog signals from a cassette deck, VCR, or record player.

Auto detect:

In "FULL AUTO" mode (AUTO DETECT indicator light up), the receiver detects the digital or analog input signals automatically. Priority is given to digital signal during input mode selection. The receiver will select the input mode and listening mode automatically during playback to match the type of input signal (Dolby Digital, PCM, DTS) and the speaker setting. The OPTICAL and COAXIAL indicator on the display will light up when digital signal is detected. If the input signal is analog, the ANALOG indicator will light up.

To keep the receiver set to the currently selected listening mode, use the INPUT MODE key to select "DIGITAL MANUAL" (manual sound). However, even when this setting is selected, there may be cases in which the listening mode is selected automatically to match a Dolby Digital source signal depending on the combination of listening mode and source signal.

If the INPUT MODE key is pressed quickly, sound may not be produced. Press the INPUT MODE key again.

Connecting audio components

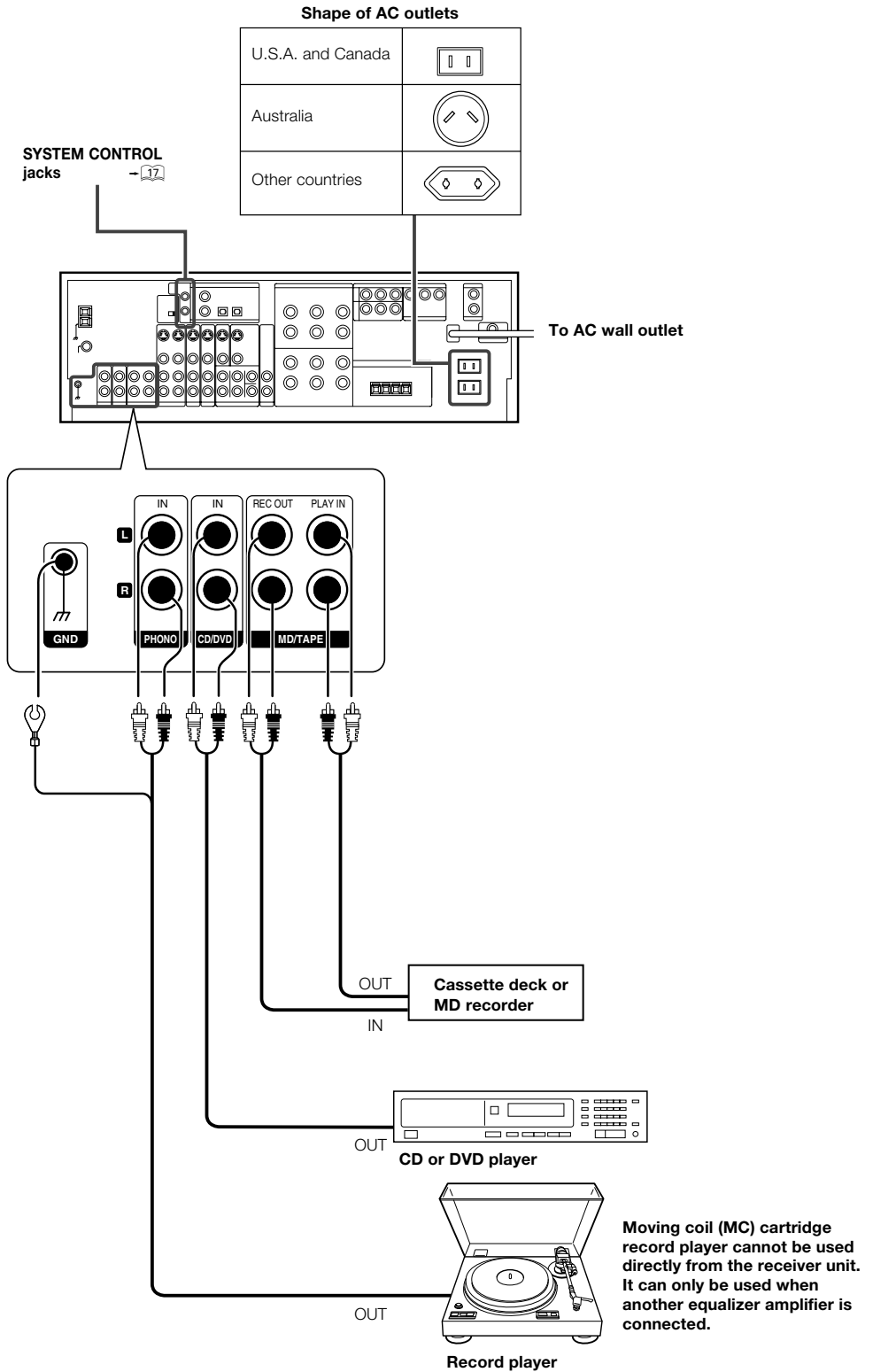

Connecting video components

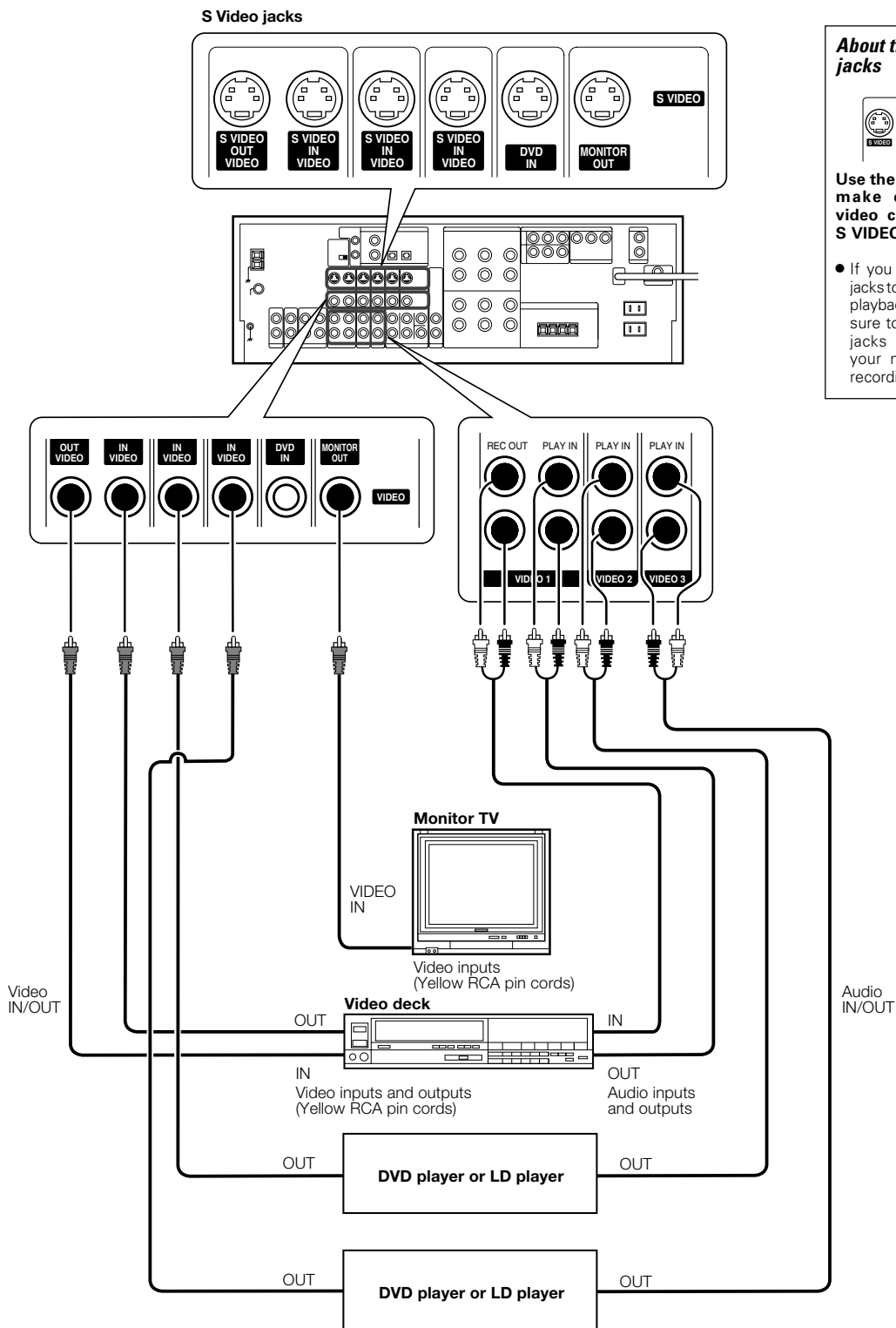

A video component with digital audio outputs should be connected to the VIDEO 2 or VIDEO 3 jacks.

Digital connections

The digital in jacks can accept DTS, Dolby Digital, or PCM signals. Connect components capable of outputting DTS, Dolby Digital, or standard PCM (CD) format digital signals.

If you have connected any digital components to the receiver, be sure to read the "Input mode settings" section carefully.

8

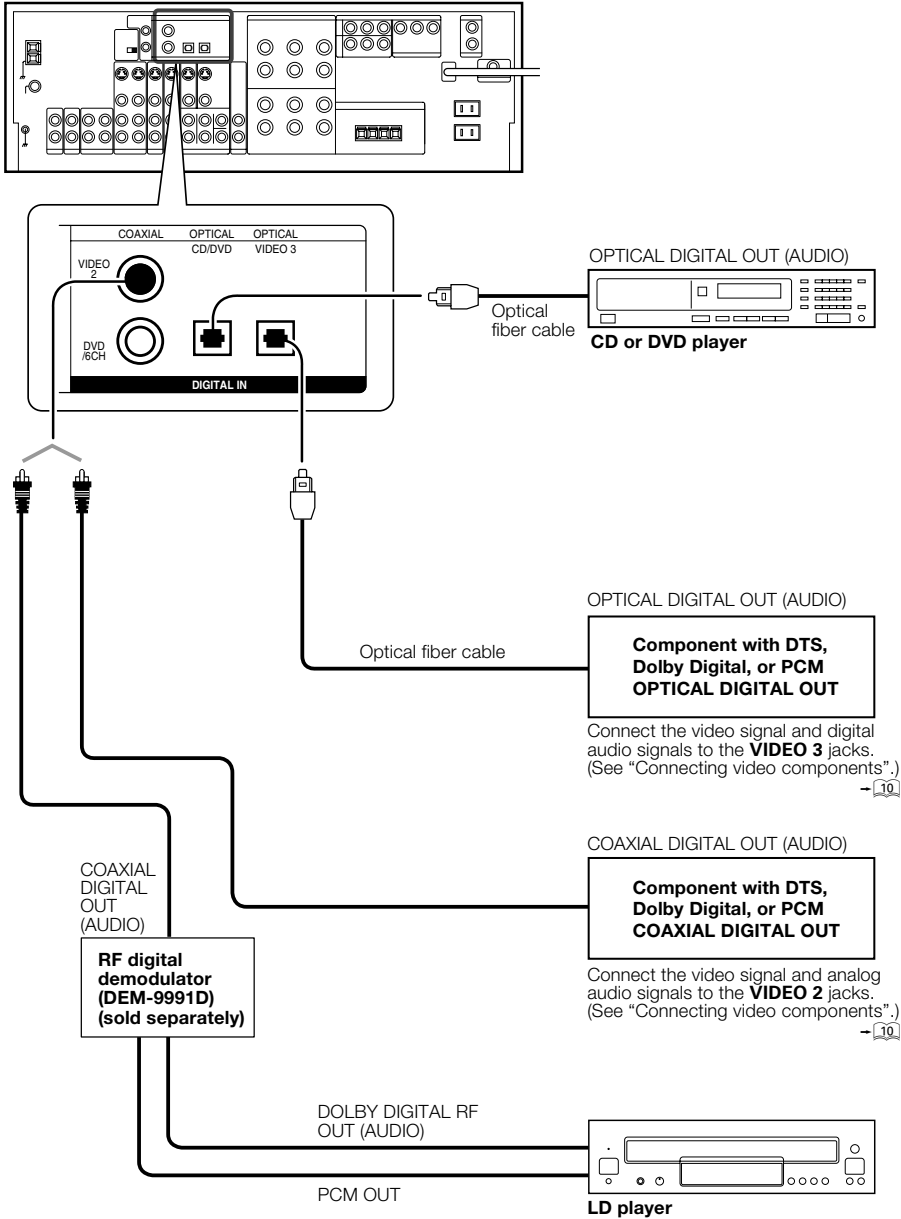

To connect an LD player with a DIGITAL RF OUT, connect the LD player to the KENWOOD RF digital demodulator (DEM-9991D). Next, connect the DIGITAL OUT jacks of the demodulator to the DIGITAL IN jacks of the receiver. Connect the video signal and analog audio signals to the VIDEO 2 or VIDEO 3 jacks. (See "Connecting video components".)

Connecting video components (COMPONENT VIDEO)

If you have connected the receiver to a video component with COMPONENT jacks, you can get a better picture quality than by connecting to the S-VIDEO jacks.

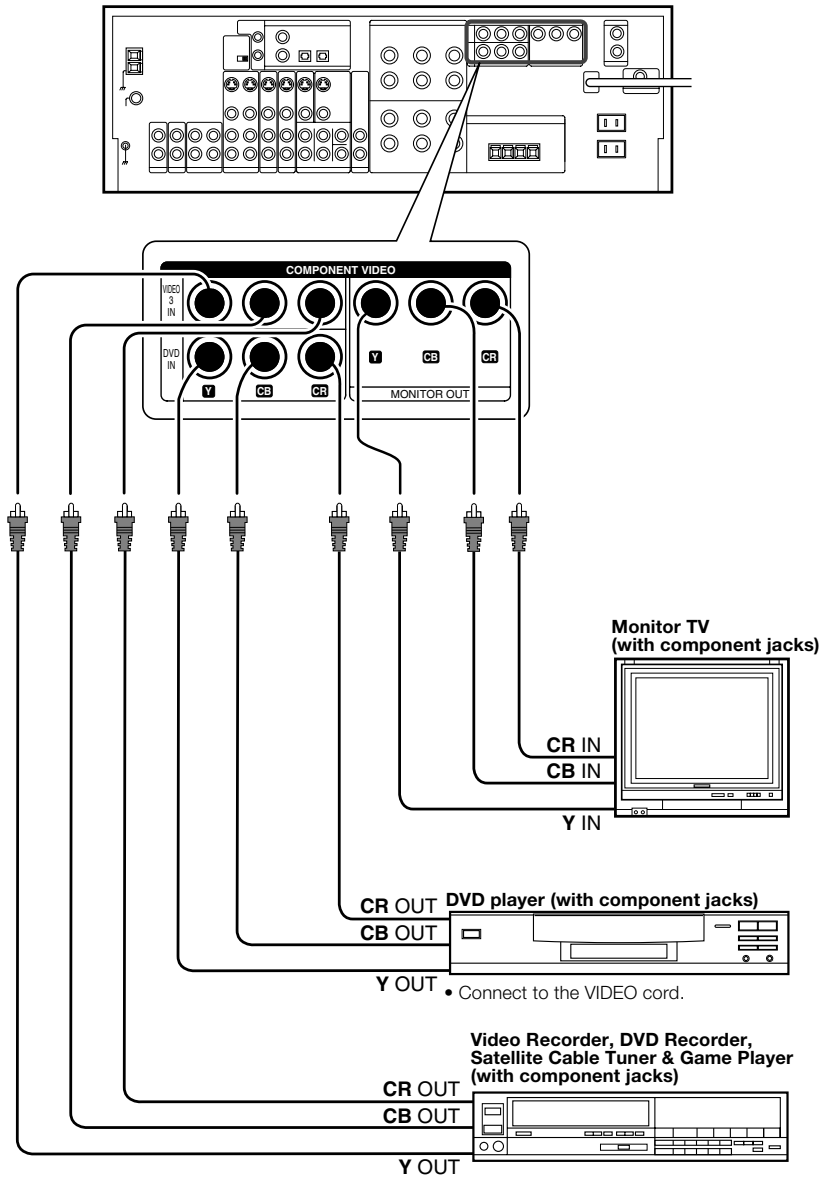

When connecting the TV to the COMPONENT jacks, be sure to connect all the other components to the COMPONENT jacks.

Connecting a DVD player (6-channel input)

If you have connected a DVD player to the receiver with digital connection, be sure to read the "Input mode settings" section carefully.

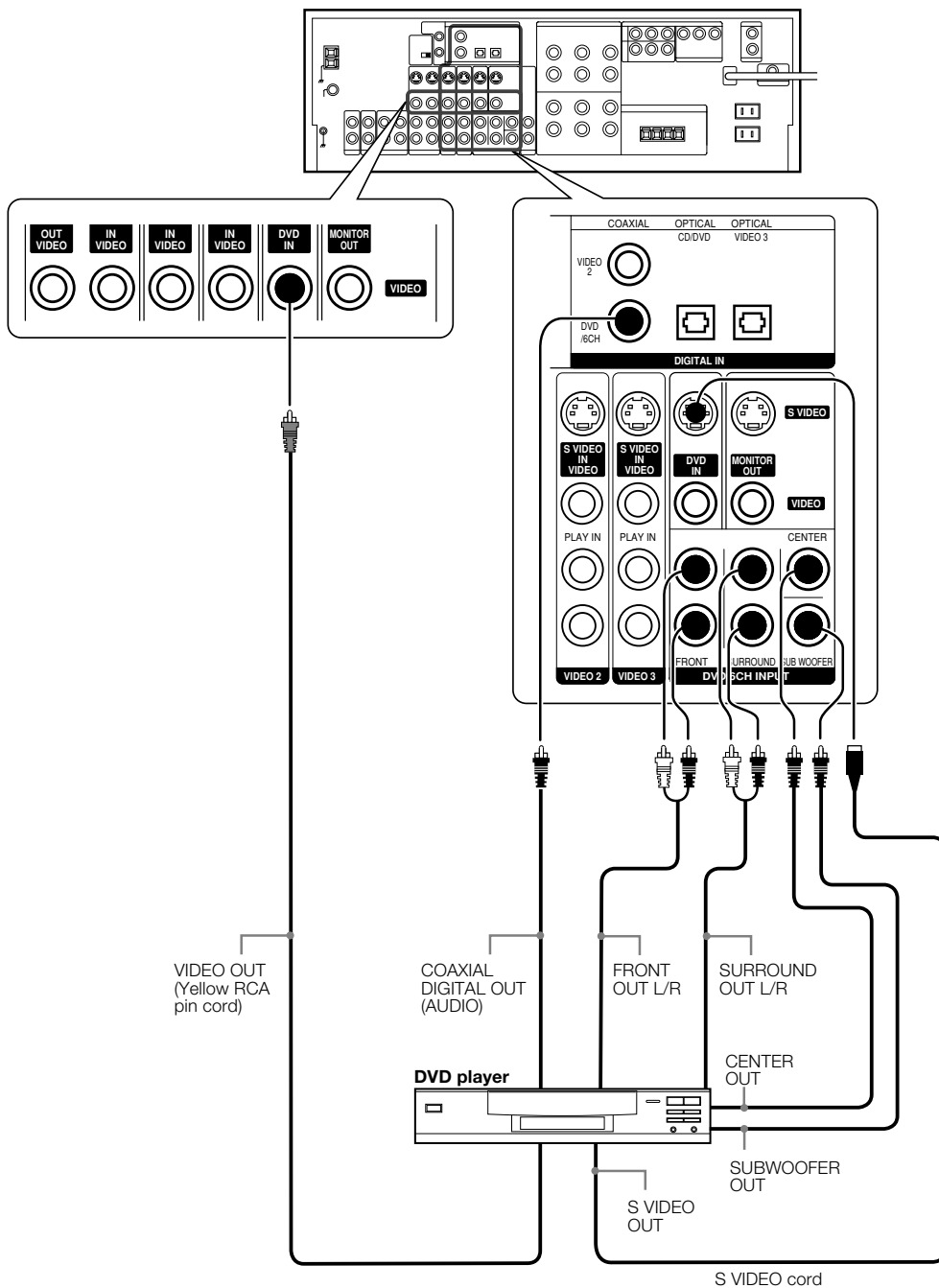

Connecting the terminals

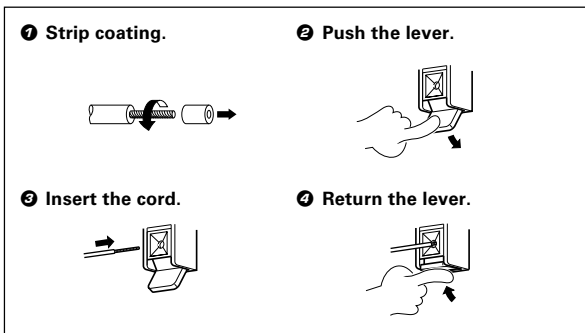
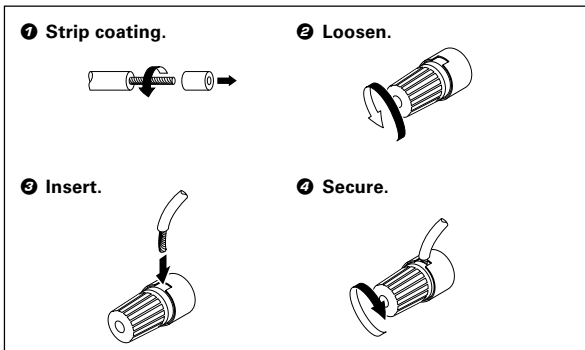

Connection of banana plugs (For the U.S.A. and Canada)

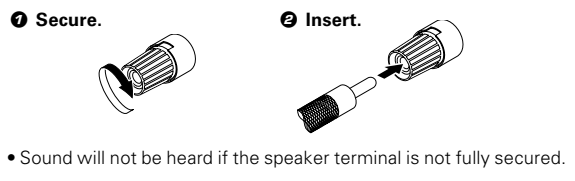

- Never short circuit the + and – speaker cords.
- If the left and right speakers are connected inversely or the speaker cords are connected with reversed polarity, the sound will be unnatural with ambiguous acoustic imaging. Be sure to connect the speakers correctly.

Speaker impedance

After confirming the speaker impedance indications printed on the rear panel of the receiver, connect speakers with matching impedance ratings. Using speakers with a rated impedance other than that indicated on the rear panel of the receiver could result in malfunctions or damage to the speakers or receiver.

Speaker placement

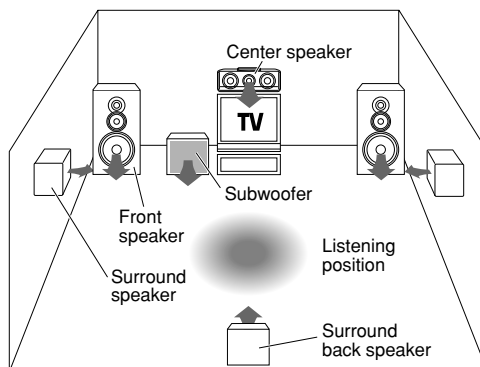

Front speakers : Place at the front left and right of the listening position. Front speakers are required for all surround modes.

Center speaker : Place front and center. This speaker stabilizes the sound image and helps recreate sound motion. Required for surround playback.

Surround speakers : Place at the direct left and right, or slightly behind, the listening position at even heights, approximately 1 meter above the ears of the listeners. These speakers recreate sound motion and atmosphere. Required for surround playback.

Subwoofer : Reproduces powerful deep bass sounds.

Surround back speaker : Place the speaker directly at the rear of the listening position. The optimum position depends mainly on the room condition.

- Although the ideal surround system consists of all the speakers listed above, if you don't have a center speaker or a subwoofer, you can divide those signals between the available speakers in the speaker settings steps to obtain the best possible surround reproduction from the speakers you have available.

Channel space switching

(Except for the U.S.A., Canada, U.K., and Australia)

The space between radio channels has been set to the one that prevails in the area to which the system is shipped. However, if the current channel space setting does not match the setting in the area where the system is to be used, for instance when you move from area 1 or area 2 shown in the following table or vice versa, proper reception of AM/FM broadcasts cannot be expected. In this case, change the channel space setting in accordance with your area by referring to the following table.

	Area	CHANNEL Space Frequency
1	U.S.A., Canada and South American countries	FM: 100 kHz AM: 10 kHz
2	Other countries	FM: 50 kHz AM: 9 kHz

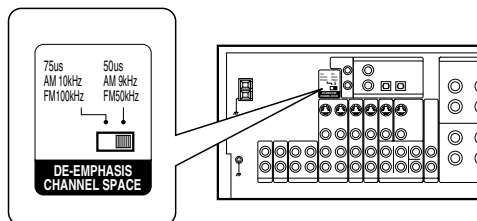

Turn the power OFF by pressing the POWER key before moving the switch level. Move switch lever to match your area with a small screwdriver or other pointed tool, then turn the power on again.

Connecting to the AV AUX jacks

The **AV AUX** jacks are convenient for connection of video components such as a camcorder or a video game.

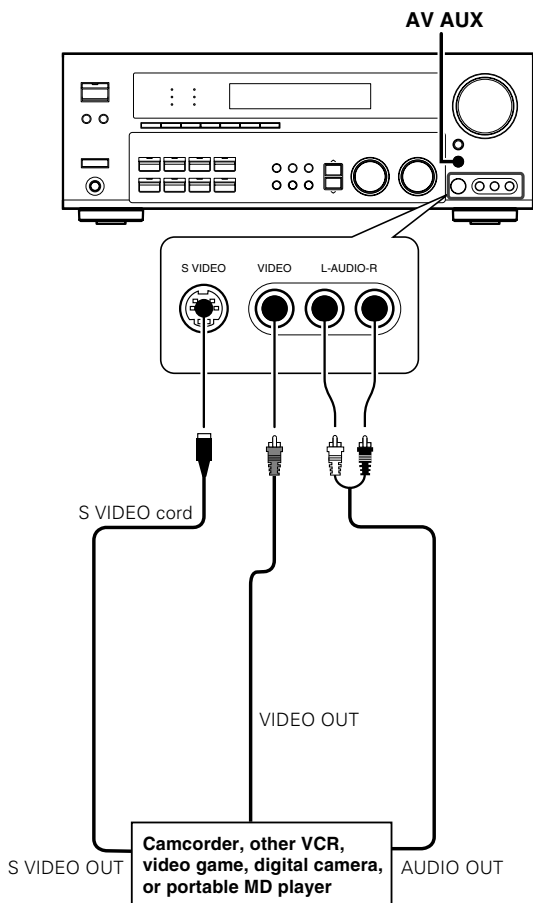

- To select the source connected to the AV AUX jacks press **AV AUX** key. — 23
- When you connect the audio source such as the MD player, you do not need to connect the video cable.
- When you connect the unit and the component with the **S VIDEO** cord, you can get better picture quality.

Connecting the antennas

AM loop antenna

The supplied loop antenna is for use indoors. Place it as far as possible from the receiver, TV set, speaker cords and power cord, and adjust the direction for best reception.

AM antenna terminal connections

- 1 Push lever.
- 2 Insert cord.
- 3 Release lever.

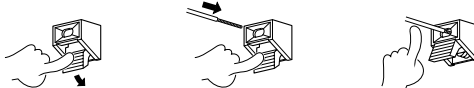

FM indoor antenna

The supplied indoor antenna is for temporary use only. For stable signal reception we recommend using an outdoor antenna. Disconnect the indoor antenna when you connect one outdoors.

FM antenna terminal connections

Insert cord.



FM outdoor antenna

Lead the 75Ω coaxial cable connected to the FM outdoor antenna into the room and connect it to the FM 75Ω terminal.

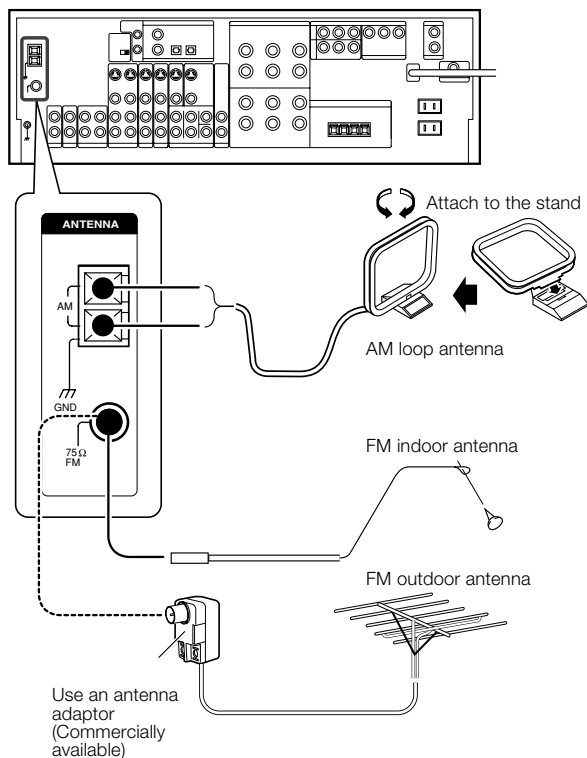

Use an antenna adaptor (Commercially available)

Connecting the system control

Connecting system control cords after connecting a KENWOOD audio component system lets you take advantage of convenient system control operations.

This unit is compatible only with the [SL16] mode. The system control operation is not available if the unit is connected in the [XS8], [XS], or [XR] connection mode.

If your component has the mode select switch, set the connected components to the [SL16] mode.

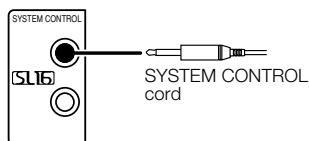

- You may connect the system control cord to either the up or down jack.

EXAMPLE: [SL16] mode connections

The underlined portion represents the setting of the system control mode.

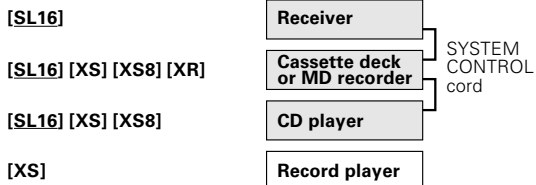

- In order to take advantage of the system control operations, the components must be connected to the correct jacks. To use a CD player it must be connected to the CD jacks. To use a cassette deck (or MD recorder) it must be connected to the MD/TAPE jacks. When using more than one CD player (etc.) only the one connected to the specified jacks may be connected for system control.
- Some CD players and cassette decks are not compatible with the [SL16] system control mode. Do not make system connections with equipment that is not [SL16] compatible.
- Some MD players are not system control compatible. You cannot make system control connections to this kind of equipment.

Notes

- [SL16] equipment cannot be combined with [XR], [XS], and [XS8] equipment for system operations. If your equipment consists of this kind of combination, please do not connect any system control cords. Even without system control cords, normal operations can be carried out without effecting performance.
- Do not connect system control cords to any components other than those specified by KENWOOD. It may cause a malfunction and damage your equipment.
- Be sure the system control plugs are inserted all the way in to the system control terminals.

SYSTEM CONTROL OPERATIONS

Remote Control

Lets you operate this unit with the system remote supplied with the receiver.

Automatic Operation

When you start playback from a source component, the input selector on this unit switches to that component automatically.

Synchronized Recording

Lets you synchronize recording with the start of playback when recording from CD, MD or analog discs.

Registering setup codes for KENWOOD audio components

If you own remote controllable KENWOOD audio components that are not compatible with system control, registering the setup code enables you to control those components using the remote control supplied with this unit (without connecting system control cords). To register setup codes for your remote controllable KENWOOD audio components, see "Registering setup codes for other components".

→ 36

Connecting the RF antenna and external IR Repeater (For VR-6060 only)

The remote control for this receiver has the RF (radio frequency) and IR (infrared rays) transmission function. IR repeaters enables you to control components located in cabinets or behind glass doors. You can enjoy a wider remote control signal range by placing the RF antenna and IR repeater away from the receiver.

KENWOOD components (except DVD player): System control
Other components: (Registering setup codes) IR REPEATER

- 17
 - 36

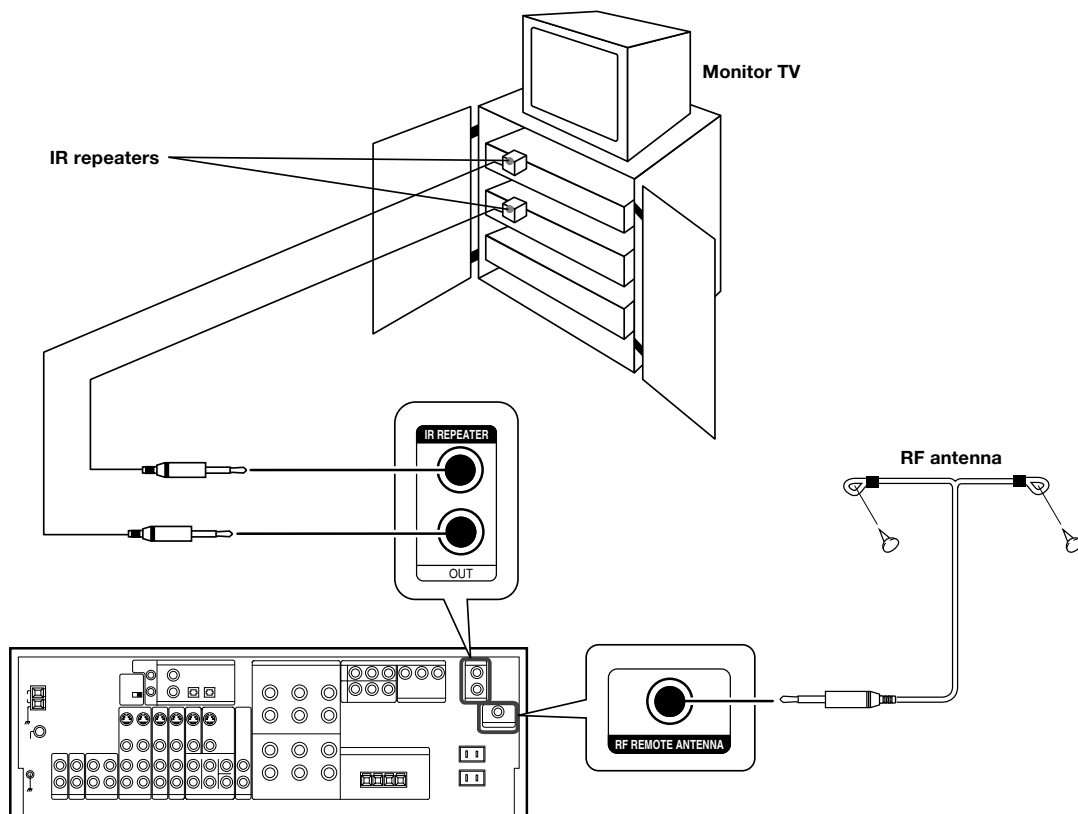

(For RF Transmitter, select either
 1. RF REMOTE Band 1, or
 2. RF REMOTE Band 2)

Connecting IR repeater

- ❶ Connect the IR repeater to the device as described in the repeater's manual.
- ❷ Connect the IR repeater cable(s) to the IR REPEATER OUT jack(s).

Notes

- IR repeaters send a signal similar to the device's own remote control. Xantech repeaters (models 282-00, 286-00, or 283-00) are compatible with your new audio-video receiver.

Connecting the RF remote antenna

- ❶ Insert the jack of the provided RF remote antenna into the RF REMOTE ANTENNA jack.
- ❷ Place the antenna wire vertically and fix it.
 - Place the antenna away from the metallic panel.

Shape of plug to be connected.

IR REPEATER OUT	
Mono Mini Plug	
IR OUT SPECIFICATION:	
Terminal	IR REPEATER OUT
To Tip	Signal
To Sleeve	Ground

Preparing the remote control

Loading the batteries

❶ Remove the cover.

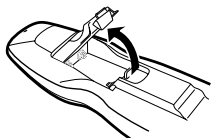

❷ Insert the batteries.

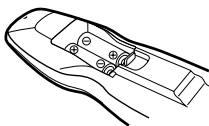

❸ Close the cover.

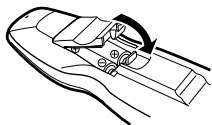

• Insert two AA-size (R6) batteries as indicated by the polarity markings.

RF remote control function (For VR-6060 only)

The remote control has the RF remote function in addition to the IR remote function. The VR-6060 can receive the remote control commands even when they are installed in a position where the IR remote signal can hardly access, for example inside a cabinet. The receiver is not equipped with the RF remote bi-directional communication function. The bi-directional communication is available only when using the IR remote function with equipments other than the receiver.

Changing the RF transmission frequency

The RF remote function may be unavailable due to radio wave cross talk, etc. In this case, the transmission frequency can be changed.

To change the RF remote transmission frequency:

❶ Change the RF switch setting.

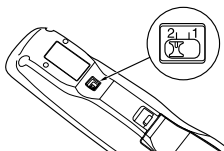

After changing the RF frequency of remote control, be also sure to change that of the receiver.

❷ Change the receiver's RF reception frequency.

- Press and hold the **SETUP** key on the front panel of the receiver for more than 2 seconds. Each time you press the **SETUP** key, the RF reception frequency changes as follows:

- ❶ "RF REMOTE BAND 1"
- ❷ "RF REMOTE BAND 2"
- ❸ "RF REMOTE OFF"

- Select the same number as the position number of the RF switch of the remote control.

Remote control operation

When the **STANDBY** indicator is lit, the power turns ON when you press the **POWER** ϕ or **SOURCE** ϕ key on the remote control. When the power comes ON, press the key you want to operate.

Operating other component range (IR Transmitter)

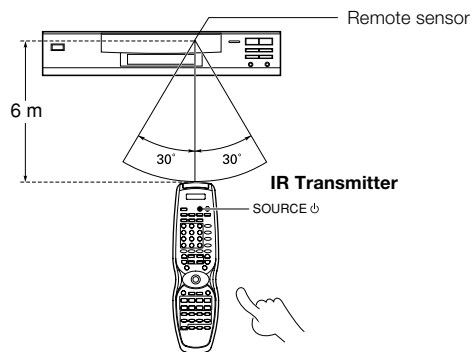

Operating receiver range (RF Transmitter)

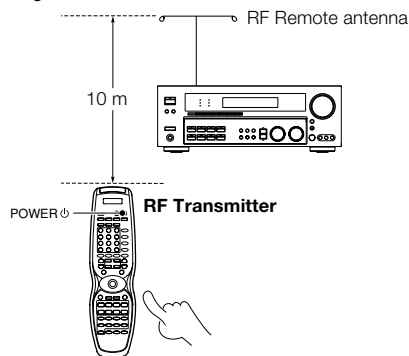

- The remote control signal received by main unit IR and RF signals.
- When pressing more than one remote control key successively, press the keys securely by leaving an interval of 1 second or more between keys.

Notes

1. The supplied batteries may have shorter lives than ordinary batteries due to use during operation checks.
2. When the remote-controllable distance gets shorter than before, replace both batteries with new ones.
3. Placing the remote sensor in direct sunlight, or in direct light from a high frequency fluorescent lamp may cause a malfunction. In such a case, change the location of the system installation to prevent malfunction.

Important notes

Here is list of adjustment which can maximize the operation of your remote control. For optimal operation of the remote control:

- ❶ Aim the remote control toward the room where the receiver is located.
- ❷ Do not position the receiver and remote control near metal (such as heat ducts). Metal can absorb RF signals.
- ❸ Make sure the batteries in the remote control are fully charged. Weak batteries will affect the range of the remote control.
- ❹ When there is an obstruction around other equipments that send signal from the remote control, the control distance of the RF remote signal will be short.

Note

- The tests for range limits of the remote control and the receiver are conducted in open-air distance test. Actual distance of the signal will be based on the construction of the building where the unit is being used in as well as other factors such as outside interference.

Preparing for surround sound

Speaker settings

To enable you to obtain optimum enjoyment from the receiver's listening modes, make sure to complete the speaker settings (subwoofer, front, center, and surround speakers) as described below.

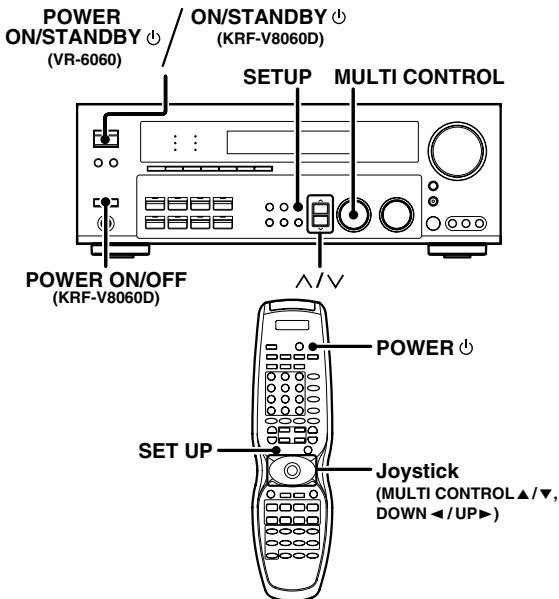

1 Turn on the power to this receiver by pressing the POWER ON/STANDBY (for VR-6060) or POWER ON/OFF and ON/STANDBY (for KRF-V8060D) key or POWER key.

2 Press the SETUP key to enter the SETUP mode.

The Surround Back and Subwoofer speaker output selections are displayed as follows:

- ① 6ch AMP SB
- ② 6ch AMP SW

Use the MULTI CONTROL knob or Joystick (▲/▼) to select the speakers. Press the SETUP key to proceed to the next SET UP selection.

Use ▲/▼ keys or Joystick (◀/▶) for the following displays.

- ① SP SETUP
- ② TEST TONE
- ③ SP DISTANCE
- ④ DISP MODE
- ⑤ EXIT

The flow of the SET UP is as follows:

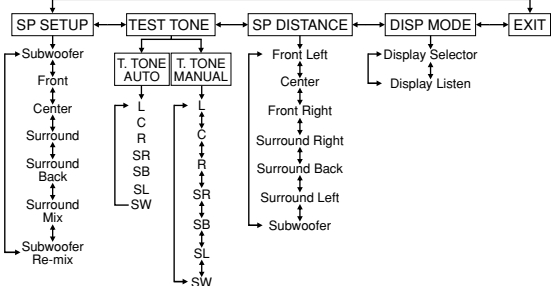

3 Select a speaker system.

➤ Select the SP SETUP and press the SETUP key again so that the subwoofer setting indication "SUBW ON" appears.

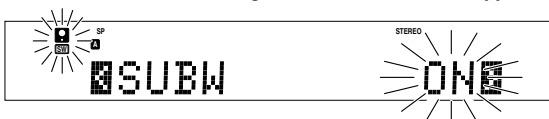

➤ Use the MULTI CONTROL knob or Joystick (▲/▼) to select the appropriate subwoofer setting.

- ① SUBW ON : Subwoofer setting mode to the receiver is ON.
- ② SUBW OFF : Subwoofer setting mode to the receiver is OFF.

- The initial setting is "SUBW ON".
- When the setting "SUBW OFF" is selected, the front speakers are automatically set to "FRNT LARGE" and the procedure skips to step 4.
- Before step 4, press the SETUP key to accept the setting.
- When subwoofer output sound is required, select "FRNT NORMAL", or select both "FRNT LARGE" and "SWRE-MIXON".
- After setting SW (subwoofer) from OFF to ON, 6ch AMP setup display will appear to enable you to re-select either SW or SB from the surround back or subwoofer speaker terminal.

➤ Press the ^ key or Joystick (▶) to accept the setting.

- The front speakers setting indication "FRNT" appears.

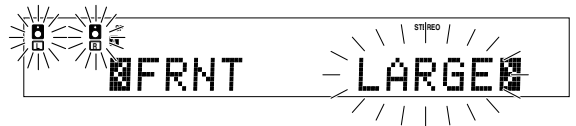

➤ Use the MULTI CONTROL knob or Joystick (▲/▼) to select the appropriate front speakers setting.

- ① FRNT LARGE : Large front speakers are connected to the receiver.
- ② FRNT NORMAL : Average size front speakers are connected to the receiver.

- For "FRNT LARGE" selection, no sound will be heard from subwoofer speaker even when it is set to ON. However, if you select "SW RE-MIX ON" when subwoofer is selected, you will be able to hear sound from the subwoofer.
- When in STEREO mode, the sound goes directly to front speaker.

➤ Press the ^ key or Joystick (▶) to accept the setting.

- The center speaker setting indication "CNTR" appears.

➤ Use the MULTI CONTROL knob or Joystick (▲/▼) to select the appropriate center speaker setting.

If you selected "LARGE" as the front speakers setting,

- ① CNTR LARGE : A large center speaker is connected to the receiver.
- ② CNTR NORMAL : An average size center speaker is connected to the receiver.
- ③ CNTR OFF : Center speaker setting mode to the receiver is OFF.

If you selected "NORMAL" as the front speakers setting,

- ① CNTR ON : Center speaker setting mode to the receiver is ON.
- ② CNTR OFF : Center speaker setting mode to the receiver is OFF.

➤ Press the ^ key or Joystick (▶) again to accept the setting.

- The surround speaker setting indication "SURR" appears.

➤ Use the MULTI CONTROL knob or Joystick (▲/▼) to select the appropriate surround speaker setting.

If you selected "LARGE" as the center speaker setting,

- ① SURR LARGE : Large surround speakers are connected to the receiver.
- ② SURR NORMAL : Average size surround speakers are connected to the receiver.
- ③ SURR OFF : Surround speaker setting mode to the receiver is OFF.

If you selected other than "LARGE" as the center speaker setting,

- ① **SURR ON** : Surround speaker setting mode to the receiver is ON.
- ② **SURR OFF** : Surround speaker setting mode to the receiver is OFF.

• When the setting "SURR OFF" is selected, the procedure skips to step ④.

- ③ Press the **^** key or Joystick (**▶**) again to accept the setting.
 - The surround speaker setting indication "SB" appears.
- ④ Use the **MULTI CONTROL** knob or Joystick (**▲/▼**) to select appropriate surround back speaker setting.

If you selected "LARGE" as the surround speaker setting,

- ① **SB NORMAL** : Average size surround back speaker is connected to the receiver.
- ② **SB LARGE** : Large surround back speaker is connected to the receiver.
- ③ **SB OFF** : Surround back speaker setting mode to the receiver is OFF.

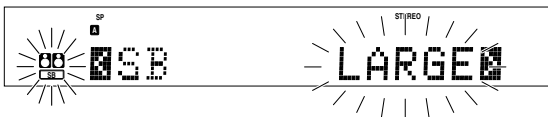

If you selected "NORMAL" as the surround speaker setting,

- ① **SB ON** : Surround back speaker setting mode to the receiver is ON.
- ② **SB OFF** : Surround back speaker setting mode to the receiver is OFF.

• After setting SB (surround back) from OFF to ON, 6ch AMP setup display will appear to enable you to re-select either SW or SB from the surround back or subwoofer speaker terminal.

- ③ Press the **^** key or Joystick (**▶**) again to accept the setting and "SURR:MIX" appears.
 - Surr:mix is when the SL and SR speakers signals are mixed to produce sound from the surround back speaker which would enable the listener to enjoy sound coming from the back.

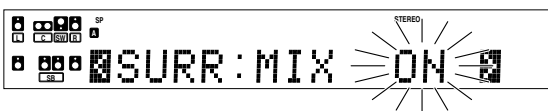

- ④ Use the **MULTI CONTROL** knob or Joystick (**▲/▼**) to select the following.

- ① **SURR:MIX ON** : Surround mix setting mode to the receiver is ON.
- ② **SURR:MIX OFF** : Surround mix setting mode to the receiver is OFF.

• If surround back speaker is turned OFF, SURR:MIX setting is not visible and the procedure skips to step ④.

- ③ Press the **^** key or Joystick (**▶**) again to accept the setting.
 - The subwoofer re-mix setting indication "SW RE-MIX" appears.

- ④ Use the **MULTI CONTROL** knob or Joystick (**▲/▼**) to select the appropriate subwoofer re-mix setting.

- ① **SW RE-MIX ON** : Subwoofer re-mix setting mode to the receiver is ON.
- ② **SW RE-MIX OFF** : Subwoofer re-mix setting mode to the receiver is OFF.

• If subwoofer is turned OFF, subwoofer re-mix setting is not visible.

- ⑤ Press the **SETUP** key again to return to the main setup displays.
 - The receiver enters the speaker volume level adjustment mode.
 - In steps ② and ③, indications appear only for the selected channels of the speakers that require adjusting.

4 Adjust the speaker volume level.

From your usual listening position, adjust the volume levels. The volume levels from each speaker should be the same.

- ① Press the **^/▼** keys or Joystick (**◀/▶**) to select **TEST TONE**.

- ② Press the **SETUP** key for the following displays:

- ① **T.TONE AUTO**
- ② **T.TONE MANUAL**

- ③ The selection of **AUTO/MANUAL TEST TONE** is done by the **MULTI CONTROL** knob or Joystick (**▲/▼**). Press the **SETUP** key again to begin **TEST TONE**.

Use the **MULTI CONTROL** knob or Joystick (**▲/▼**) to adjust the volume level of the test tone output from the speaker channel to be adjusted.

For **AUTO** selection, the first test tone is heard from the front left speaker for 2.5 seconds. The next test tone is heard from the speakers in the following sequence for 2 seconds each.

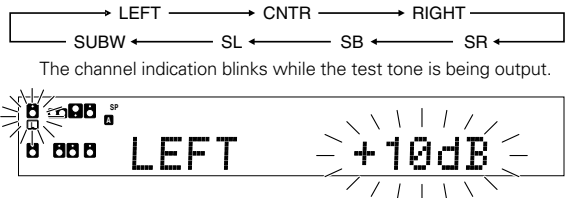

- If you change the volume level settings for the speakers while listening to music, the settings referred to on this page are also changed.
- If the speaker setting selects are OFF, the speaker level settings are reset.

For **MANUAL** selection, press the **^/▼** keys or Joystick (**◀/▶**) each time to select the speaker channel.

- ④ Press the **SETUP** key again.
 - The test tone is turned off and return to the main setup displays.

5 Input the distance to the speakers.

- ① Press the **^/▼** keys or Joystick (**◀/▶**) to select the **SP DISTANCE** on setup displays and press the **SETUP** key again.

- ② Measure the distance from the listening position to each of the speakers.

jot down the distance to each of the speakers.

- Distance to Front left speaker (L) : ___ feet (meters)
- Distance to Center speaker (C) : ___ feet (meters)
- Distance to Front right speaker (R) : ___ feet (meters)
- Distance to Surround right (SR) : ___ feet (meters)
- Distance to Surround back (SB) : ___ feet (meters)
- Distance to Surround left (SL) : ___ feet (meters)
- Distance to Subwoofer (SW) : ___ feet (meters)

- ③ Use the **^/▼** keys or Joystick (**◀/▶**) to select the speakers and the **MULTI CONTROL** knob or Joystick (**▲/▼**) to adjust the distance to the front speakers.

The speaker indicator to be adjusted blinks.

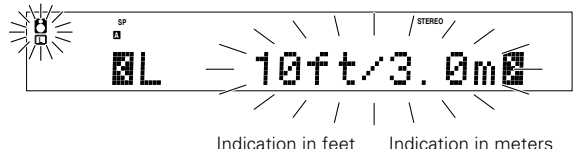

Indication in feet Indication in meters

- The allowable setting range is 1 to 30 feet (0.3 to 9.0 m), adjustable in 1 foot (0.3 m) increments.

Continued to next page.

- 4 Repeat steps 3 to input the distance for each of the speakers.
- 5 Press the **SETUP** key again to return to main setup displays.
 - The speakers you have selected should appear on the display. Confirm that all the speakers have been correctly selected.

6 Select the display mode.

- 1 Press the \wedge/\vee key or Joystick (\leftarrow/\rightarrow) to select the **DISP MODE**.
- 2 Press the **SETUP** key for the following displays:
 - 1 **DISP SELECTOR** : Displays the current input selector.
 - 2 **DISP LISTEN** : Displays the current listen mode.
- 3 Use the **MULTI CONTROL** knob or Joystick ($\blacktriangle/\blacktriangledown$) to select the display mode.



- 4 Press the **SETUP** key again to accept the setting.
- 5 Use the \wedge key or Joystick (\rightarrow) to select **EXIT**.

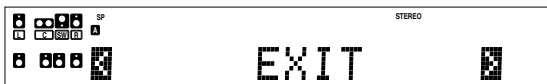

- 6 Press the **SETUP** key to exit the **SET UP** mode.

Input level adjustment (analog sources only)

If the input level of an analog source signal is too high, the CLIP indicator will blink to indicate the source signal. Adjust the input level.



- 1 Use the **Input Selector** keys to select the source of which the input level you want to adjust.
 - You can store a separate input level for each input source.

- 2 Press the **SOUND** and \wedge/\vee keys or Joystick (\leftarrow/\rightarrow) repeatedly until the "INPUT" indication appears.
- 3 Use the **MULTI CONTROL** knob or Joystick ($\blacktriangle/\blacktriangledown$) to adjust the input level.

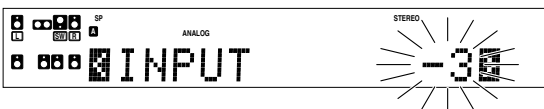

- The adjustment mode is displayed for approximately 8 seconds.
- The input level may be adjusted to any one of three settings: 0dB, -3dB, and -6dB. (The initial setting is 0dB.)

- 4 Press the **SOUND** key again to return to the input indication.

Normal playback

Preparing for playback

Some preparatory steps are needed before starting playback.

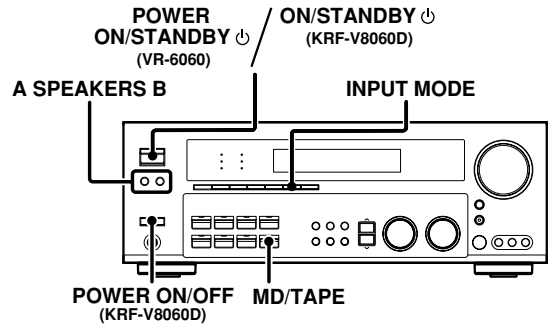

Turning on the receiver

- 1 Turn on the power to the related components.
- 2 Turn on the power to this receiver by pressing the **POWER ON/STANDBY** key (for VR-6060) or **POWER ON/OFF** and **ON/STANDBY** key (for KRF-V8060D) key.

Selecting the input mode

If you have selected a component connected to the **CD/DVD**, **VIDEO 2**, **VIDEO 3** or **DVD/6CH** jacks, make sure that the input mode setting is correct for the type of audio signal to be used. - 8

Selecting MD/TAPE

Select the source name corresponding to the component connected to the **MD/TAPE** jacks. The initial factory setting is "TAPE". To change the source to "MD", follow the steps below:

Hold down the MD/TAPE key for more than 2 seconds.

- The source indication changes to "MD".
- To return to the original indication, repeat the above procedure.

Selecting the speaker system

Press the **A SPEAKERS B** key to select the speaker system to be used.

- A ON** : Sound from the speakers connected to the **SPEAKERS A** terminals on the rear panel.
- B ON** : Sound from the speakers connected to the **SPEAKERS B** terminals on the rear panel. No sound will be heard from the subwoofer.
- A+B ON** : Sound from both the speakers connected to the **SPEAKERS A** and **B** terminals on the rear panel.
- A+B OFF** : No sound from the speakers. Use this setting when listening with headphones for stereo sound in all playback modes. The display segments are different depending on the type of input signal.

The indicator for the speakers you want to use should be lit.

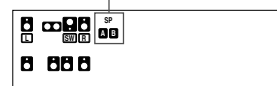

- Selecting "6CH INPUT" by pressing the **INPUT MODE** key, whereby "DVD/6CH" is the input source will cause **SPEAKERS A** to be selected automatically.

Listening to a source component

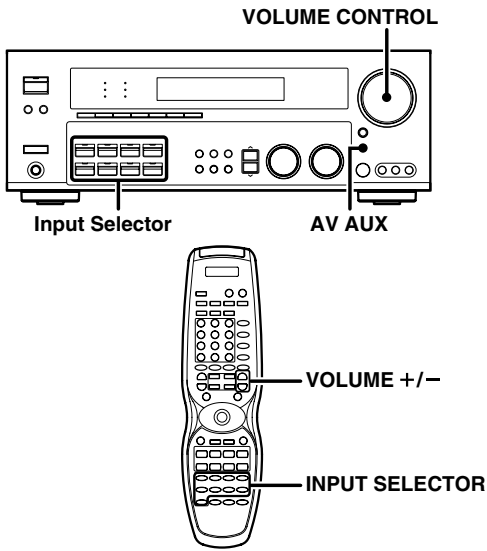

- 1 Use the **Input Selector** and **AV AUX** keys to select the source you want to listen to.

Selecting a source using each key.

- 1 "DVD/6CH"
- 2 "CD/DVD"
- 3 "PHONO"
- 4 "TUNER"
- 5 "VIDEO 1"
- 6 "VIDEO 2"
- 7 "VIDEO 3"
- 8 "MD/TAPE"
- 9 "AV AUX"

- 2 Start playback from the selected source.

- 3 Use the **VOLUME CONTROL** knob or **VOLUME +/-** keys to adjust the volume.

Adjusting the sound

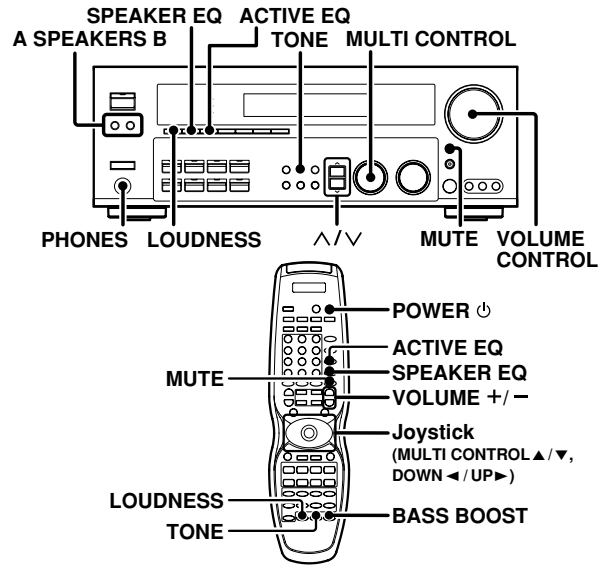

Adjusting the TONE

You can adjust the sound quality when the receiver is in the PCM stereo and analog stereo mode.

- 1 Press the **TONE** key to select the TONE mode.
- 2 Use the **MULTI CONTROL** knob or Joystick ($\blacktriangle/\blacktriangledown$) to select TONE ON/OFF.



- 3 When in TONE ON selection, press the **TONE** key for the following displays.

BASS : Select this to adjust the low frequency range.
TREBLE : Select this to adjust the high frequency range.

- 4 Use the **MULTI CONTROL** knob or Joystick ($\blacktriangle/\blacktriangledown$) to adjust the sound quality.



- The bass and treble levels are adjustable from -10 to +10 in 2 step increments.
- The adjustment item is displayed for approximately 8 seconds.

Once-touch low frequency emphasis (BASS BOOST) (remote control only)

You can adjust the sound quality when the receiver is in the PCM stereo and analog stereo modes.

Press the BASS BOOST key.

- Press the key once to select the maximum (+10) low frequency emphasis setting.
- This key does not function when the receiver is in the sound quality or ambience effects adjustment mode.

Switching back to the previous setting

Press the **BASS BOOST** key again.

Normal playback

Adjusting the LOUDNESS mode

You can adjust the Loudness function which controls the low volume settings to maintain the music's richness. The adjustment can be made when the receiver is in the PCM stereo and analog stereo mode.

Press the **LOUDNESS** key to turn the **LOUDNESS** setting ON.

To cancel

Press the **LOUDNESS** key again so that the "LOUDNESS" indicator goes off.

Muting the sound

The **MUTE** key lets you mute the sound of the speakers.

Press the **MUTE** key.

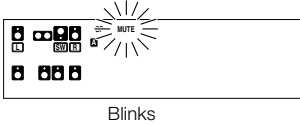

To cancel

Press the **MUTE** key again so that the "MUTE" indicator goes off.

- MUTE ON can also be deactivated by turning the VOLUME CONTROL knob or pressing VOLUME +/- keys.

ACTIVE EQ mode

You can enjoy a more impressive sound effect when ACTIVE EQ is turned ON during Dolby Digital and DTS playback and, when in PCM and analog stereo mode.

Press the **ACTIVE EQ** key for the following selections;

- ① **ACTIVE EQ MUSIC** : Effective when listening to music. (The ACTIVE EQ indicator lights up.)
- ② **ACTIVE EQ CINEMA** : Effective when watching a movie. (The ACTIVE EQ indicator lights up.)
- ③ **ACTIVE EQ TV** : Effective when watching TV. (The ACTIVE EQ indicator lights up.)
- ④ **ACTIVE EQ OFF** : The ACTIVE EQ function is turned OFF. (The ACTIVE EQ indicator goes off.)

- "ACTIVE EQ" will scroll from right to left.
- When ACTIVE EQ and SPEAKER EQ are OFF and ACTIVE EQ (MUSIC) is turned ON, SPEAKER EQ (SMALL) will turn ON automatically.
- ACTIVE EQ function will not be available when REC MODE, AUTO TUNING or PRESET MEMORY is ON, and during 96kHz LPCM playback.

SPEAKER EQ mode

SPEAKER EQ's function will automatically detect the various features of each speaker and effectively creates a stereoscopic sound effect.

Press the **SPEAKER EQ** key to switch the following setting;

- ① **SPEAKER EQ SMALL** : To select a small size speaker. (The SPEAKER EQ indicator lights up.)
- ② **SPEAKER EQ NORMAL** : To select an average size speaker. (The SPEAKER EQ indicator lights up.)
- ③ **SPEAKER EQ LARGE** : To select a large size speaker. (The SPEAKER EQ indicator lights up.)
- ④ **SPEAKER EQ OFF** : The SPEAKER EQ function is turned OFF. (The SPEAKER EQ indicator goes off.)

- "SPEAKER EQ" will scroll from right to left.
- SPEAKER EQ cannot be turned OFF when ACTIVE EQ is turned ON.
- SPEAKER EQ function will not be available when REC MODE, AUTO TUNING or PRESET MEMORY is ON, and during 96kHz LPCM playback.

Listening with headphones

- ① Press the **A** and **B Speaker** keys so that the speaker indicator goes off.

Make sure the **SPEAKERS** indicators are turned off.

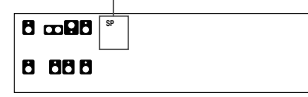

- If you turn off all of the speakers when in surround mode, the surround mode will be canceled as well, resulting in stereo playback.

- ② Connect headphones to the **PHONES** jack.

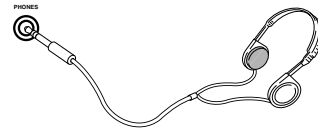

- ③ Use the **VOLUME CONTROL** knob or **VOLUME +/-** keys to adjust the volume.

Recording

Recording audio (analog sources)

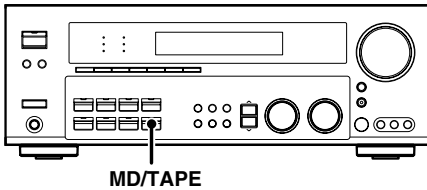

Recording a music source

- 1 Use the Input Selector keys to select the source (other than "MD/TAPE") you want to record.
- 2 Set the MD or TAPE recorder to record.
- 3 Start playback, then start recording.

Recording video

- 1 Use the Input selector keys to select the video source (other than "VIDEO 1") you want to record.
- 2 Set the video deck connected to VIDEO 1 to record.
 - Select the REC MODE to record a digital input source.
- 3 Start playback, then start recording.
 - Recording may not be normal for some video software. This is due to the copy guard condition.

Recording audio (digital sources)

Switch on the **REC MODE** to record a digital input source. Usually use the **AUTO REC MODE** to record audio input sources. When the digital mode changes during recording in the **AUTO REC MODE**, the audio input source may be interrupted momentarily.

Recording music in AUTO REC or MANUAL REC mode

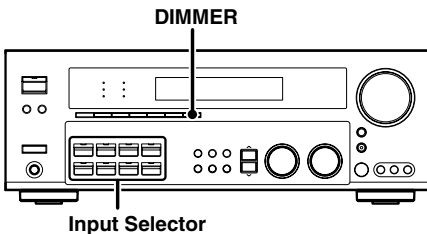

- 1 Use the Input Selector keys to select the source (CD/DVD, DVD/6CH, VIDEO 2, VIDEO 3) you want to record.
- 2 Set the MD or TAPE recorder to record.

- 3 Press and hold the DIMMER key for more than 2 seconds to select the AUTO REC or MANUAL REC mode.

- 1 **REC MODE off** : The digital input record mode is switched off.
- 2 **AUTO REC mode** : The digital input signals (DTS, Dolby Digital, or PCM) are identified automatically and converted into stereo signals that are ready for recording.
- 3 **MANUAL REC mode** : The input signal type at the moment this mode is selected is held throughout this mode.

For AUTO REC mode :

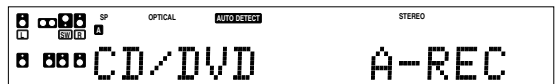

For MANUAL REC mode :



- 3 Start playback, then start recording.
 - If the audio reproduction stops in the middle due to change in the input signals, etc., press the DIMMER key.

Listening to radio broadcasts

The receiver can store up to 40 stations in the memory and recall them by one-touch operation.

Tuning radio stations

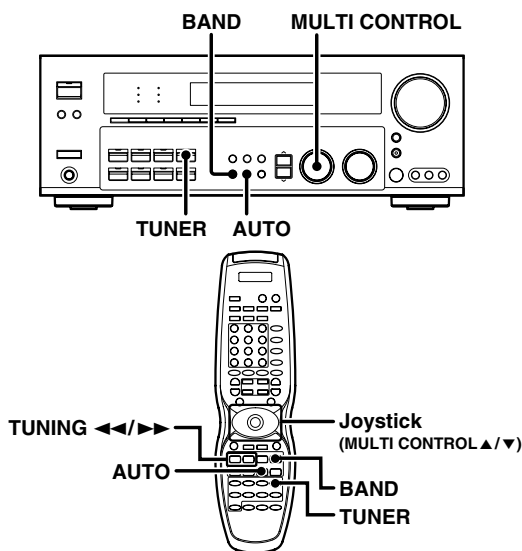

1 Use the **TUNER** key to select the tuner.

2 Use the **BAND** key to select the desired broadcast band.

Each press switches the band.

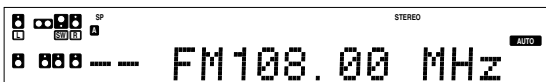

3 Use the **AUTO** key to select the desired tuning method.

Each press switches the tuning method to either auto or manual tuning.

"AUTO" indicator lights up in the display.

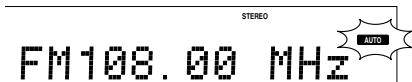

- Normally, set to "AUTO" (auto tuning). If the radio waves are weak and there is a lot of interference, switch to manual tuning. (With manual tuning, stereo broadcasts will be received in monaural.)

4 Use the **MULTI CONTROL** knob or **Joystick** (▲/▼), or **TUNING** ◀/▶ keys to select the station.

"STEREO" lights when a broadcast is being received in stereo.

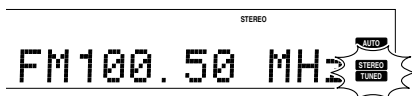

"TUNED" is displayed when a station is received.

Auto tuning : The next station is tuned automatically.

Manual tuning : Turn the knob or use the Joystick (▲/▼) to select the desired station.

Presetting radio stations manually

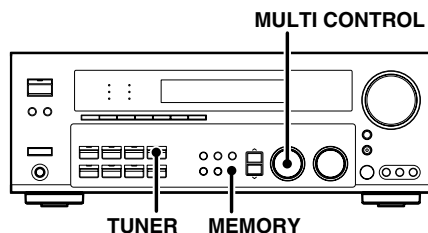

1 Tune to the station you want to store.

2 Press the **MEMORY** key while receiving the station.

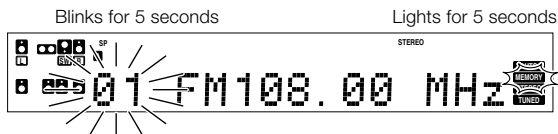

Proceed to step **3** within 5 seconds.
(If more than 5 seconds elapse, press the MEMORY key again).

3 Use the **MULTI CONTROL** knob or **Joystick** (▲/▼) to select one of the station presets (1 – 40).

4 Press the **MEMORY** key again to confirm the setting.

- Repeat steps **1**, **2**, **3**, and **4** to store as many stations as necessary.
- If you store a station at a previously used preset, the old station will be replaced by the new one.

Receiving preset stations

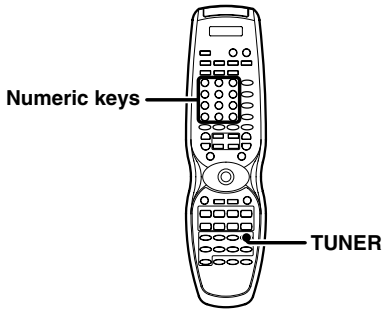

- 1 Press the **TUNER** key to select tuner as the source.
- 2 Enter the number of the preset station you want to receive (up to "40").

Press the numeric keys in the following order:

For "15", press **+10**, **5**
For "20", press **+10**, **+10**, **0**

- If you make a mistake entering a two digit number, press the **+10** key repeatedly to return to the original display and start again.



Receiving preset stations in order (P.CALL)

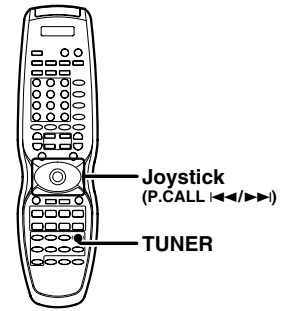

- 1 Press the **TUNER** key to select the tuner as the source.
- 2 Use the **Joystick** to adjust the **P.CALL** <<</>>> direction to select the desired station.

- Each time you push the Joystick, another preset station is received in order.

Pushing the Joystick to **P.CALL** >>> does the following:

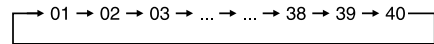

Pushing the Joystick to **P.CALL** <<< does the following:

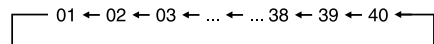

Holding the Joystick on >>> or <<< direction, lets you skip through the presets, receiving each preset station at 0.5 second intervals.

Ambience effects

This receiver is equipped with listening modes that allow you to enjoy an enhanced sonic ambience with a variety of video sources.

In order to obtain the optimum effect from the surround modes, make sure to input the proper speaker settings beforehand.

— 20 —

Surround modes

Dolby Digital

The Dolby Digital surround format lets you enjoy up to 5.1 channels of digital surround sound from Dolby Digital program sources (such as Laserdisc or DVD software marked ). Compared with previous Dolby surround, Dolby Digital provides even better sound quality, greater spatial accuracy, and improved dynamic range.

Note

Although a full set of speakers (front left, right, and center, surround left and right, and a subwoofer) is required for true 5.1 channel Dolby Digital surround sound, this receiver lets you enjoy Dolby Digital (and Dolby Surround) program sources, even if you connect only the front speakers.

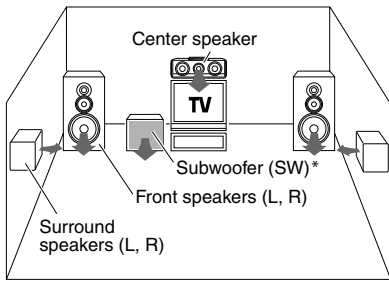

* Optional in this mode.

* LFE = Low Frequency Effects. This channel delivers separate non-directional bass signals to the subwoofer for more dynamic deep bass sound effects. Although only Dolby Digital soundtracks incorporate a separate low frequency channel, connecting a subwoofer will also improve deep bass performance in the other surround modes. The indication "LFE" appears in the display when a signal is being input for this channel.

"DTS", "DTS-ES Extended Surround" and "Neo:6" are trademarks of Digital Theater Systems, Inc.



Manufactured under license from Dolby Laboratories. "Dolby", "Pro Logic" and the double-D symbol are trademarks of Dolby Laboratories.

"Circle Surround II and the  symbol are trademarks of SRS Labs, Inc. Circle Surround II technology is incorporated under license from SRS Labs, Inc".

Dolby Digital EX

Dolby Digital EX is an extension of Dolby Digital technology, Dolby Digital EX creates six full-bandwidth output channels from 6.1-channel sources. This is done using a matrix decoder that derives three surround channels from the two in the original recording. This is achieved by using three different surround signals, surround left, surround right and surround back, each driving its own array of speakers. Think of it as adding a center channel for the rear speakers, which give more diffuse and natural surround effect, even if you wanted the ability to completely encircle the audience with sound, positioning sound effects exactly where they would be heard in real life. For best results, Dolby Digital EX should be used with movie soundtracks recorded with Dolby Digital Surround EX which contain a digital flag that will automatically activate this feature. However, for titles released prior to late 2001, this feature has to be activated manually.

Note

Although a full set of speakers (front left, right, and center, surround left and right, surround back and a subwoofer) is required for true 6.1 channel Dolby Digital Surround EX sound, this receiver lets you enjoy Dolby Digital (and Dolby Surround) program sources, even if you connect only the front speakers.

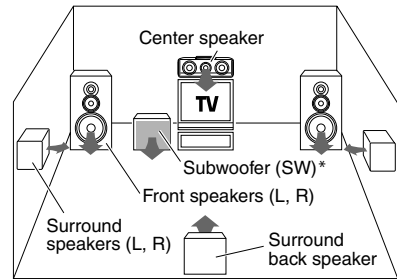

* Optional in this mode.

* LFE = Low Frequency Effects. This channel delivers separate non-directional bass signals to the subwoofer for more dynamic deep bass sound effects. Although only Dolby Digital soundtracks incorporate a separate low frequency channel, connecting a subwoofer will also improve deep bass performance in the other surround modes. The indication "LFE" appears in the display when a signal is being input for this channel.

Dolby PRO LOGIC II

Dolby Pro Logic II was designed specifically to provide a new sense of spatiality, directionality and articulation of sounds from Dolby Surround encoded sources (such as video and Laserdisc software marked ). This is achieved with an intelligent, built-in feedback logic design, a matrix surround decoding and the decoding of stereo, full bandwidth surround outputs. The PRO LOGIC II modes programmed into this receiver are "MOVIE", "MUSIC" and "PRO LOGIC". The "MOVIE" mode of the PRO LOGIC II has preset characteristics to produce a calibrated, high-level surround sound playback while the "MUSIC" mode has user-adjustable characteristics to offer the three optional controls, like "Dimension", "Center Width" and "Panorama" modes to allow optimization of the soundfields as desired. The "Dimension" control allows the user to gradually adjust the soundfield either towards the front or towards the rear; the "Center Width" control allows various adjustment of the left-center-right speakers' balance; the "Panorama" mode extends the front stereo image to include the surround speakers for an exciting "wrap-around" effect with side wall imaging.

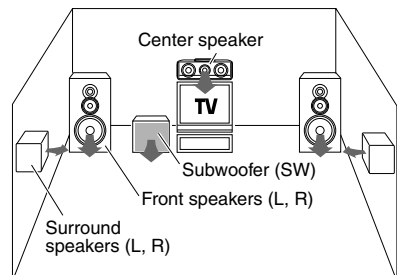

Multi channel surround sound (SRS Circle Surround II)

SRS Circle Surround II™ improves on its predecessor CS-5.1™ resulting in the CS-6.1™ system, enabling you to listen to realistic, multi-channel, surround sound playback from a stereo source or conventional surround-encoded video source. You already enjoy listening to Dolby Digital sound/DTS multi-channel sound with your multi-speakers. Now you can listen to audio CDs, MDs, Broadcast and Home Theater using your multi-speakers. You will discover a new type of sound through SRS Circle Surround II.

The CS system dramatically reduces storage space requirements for multi-channel content. It creates a listening environment that places the listener "inside" music performances, and dramatically improves both hi-fi audio and conventional surround-encoded video material. The CS decoder also includes the SRS technologies Focus™ and TruBass™. Focus electronically raises the sound stage from the speaker location to an optimal position. TruBass creates deep, rich bass in small speaker systems without the need for a subwoofer.

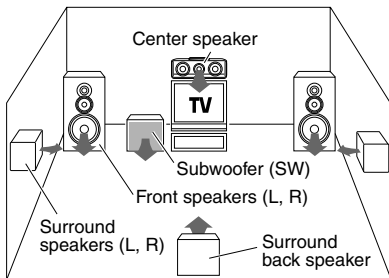

DVD 6-channel mode

Using a DVD player or the like equipped with six (5.1) output channels and the receiver, you can enjoy multi-channel encoded DVD source material in all its splendor. Since the source signals are digital and each channel is input independently, the resulting sound quality, sense of spaciousness, and dynamic range are superb.

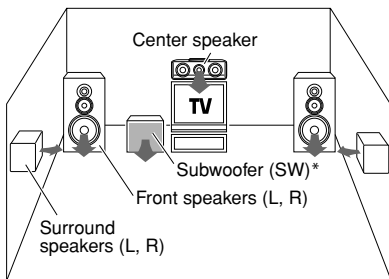

* LFE = Low Frequency Effects. This channel delivers separate non-directional bass signals to the subwoofer for more dynamic deep bass sound effects.

DSP mode

The DSP mode lets you add the atmosphere of a live concert or hall to almost any type of program source. These modes are particularly effective when used with stereo program sources, like CD, television, and FM radio. You might enjoy trying the ARENA, JAZZ CLUB, THEATER, STADIUM or DISCO mode the next time you watch a concert or sporting event!

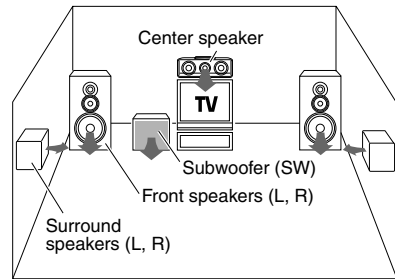

What's DSP?

DSP stands for Digital Signal Processor. The way a sound is heard in an actual environment depends on a variety of different factors. One of the most important is reverberation (the act of decaying elements of sound echoing in various places). The DSP modes produce the feeling of presence by using the DSP to create reverberation, without spoiling the sound quality of the original signal.

DTS-ES

The DTS-ES (Digital Theater System-Extended Surround) represents 6.1-channel Discrete Surround format, expanding upon 5.1 surround. DTS-ES format is a 6.1 channel sound system for movie theaters that includes an additional surround-center channel matrixed within surround-left and surround-right. It's compatible on predecessor DTS 5.1 system. The extra channel allows more accurate placement and steering of sound across the rear soundstage. The DTS-ES receiver will be required, to experience a discrete 6.1-channel mix.

The DTS-ES decoders used in home cinema systems have decoding options for utilizing the extra channel, in addition to processing existing 5.1 channel surround sound :

DTS-ES Discrete 6.1 and DTS-ES Matrix 6.1 add the surround back channel audio to the DTS 5.1-channel format to improve the acoustic positioning and makes acoustic image movement more natural with the 6.1-channel reproduction. NEO:6 is a new technology which decodes 2-channel signals into 6-channel signals using high-accuracy digital matrix technology. For best results, DTS-ES should be used with movie soundtracks recorded with DTS-ES which contain a digital flag that will automatically activate this feature. However, for some titles, this feature has to be activated manually.

According to the signals to be played back, DTS NEO:6 uses either the NEO:CINEMA mode optimized for movie playback or the NEO:MUSIC mode optimized for music playback.

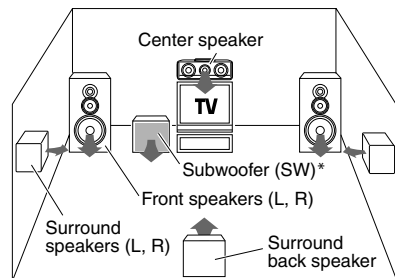

* Optional in this mode.



* LFE = Low Frequency Effects. This channel delivers separate non-directional bass signals to the subwoofer for more dynamic deep bass sound effects.

DTS has a .1 or LFE channel.

The indication "LFE" appears in the display when a signal is being input for this channel.

Surround play

The DTS compatible models can reproduce a CD, DVD, or LD carrying the DTS mark.

DOLBY DIGITAL can be used when playing DVD or LD software bearing the  mark and DOLBY DIGITAL format digital broadcasts (etc.). DOLBY PRO LOGIC can be used when playing video, DVD, or LD software bearing the  mark.

SRS Circle Surround II enables you to listen to multi channel sound from the stereo source.

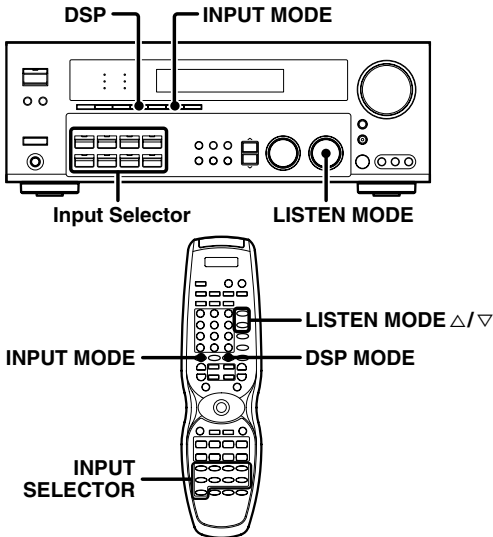

Preparations

- Turn ON related components.
- Complete "Preparing for surround sound" (speaker settings). → [20]
- Use the **Input Selector** keys to select the component you wish to play back with surround sound.
- Use the **INPUT MODE** key to select the input mode (analog or digital) for the source you wish to play back. → [8]
- Noise will be produced when a DTS source is played by selecting the analog input.

1 Start playing the video software.

2 Use the LISTEN MODE knob or LISTEN MODE Δ/∇ keys to select the listening mode.

The listening mode settings are stored separately for each input. If the input mode is set to full auto ("AUTO DETECT" lights), the receiver selects the optimal listening mode automatically based on the type of input signal and the speaker settings.

Each turn of the LISTEN MODE knob or press of the LISTEN MODE Δ/∇ keys switches the setting as listed below.

The listening mode settings are different depending on the type of input signal.

When the DOLBY DIGITAL signal is input :

(The DOLBY DIGITAL or PRO LOGIC, indicator lights up.)

- 1 **DOLBY DIGITAL** : DOLBY DIGITAL surround.
- 2 **DOLBY D EX** : DOLBY DIGITAL EX surround.
- 3 **PLII MOVIE** : PRO LOGIC II surround MOVIE mode. (The PRO LOGIC indicator lights up.)
- 4 **PLII MUSIC** : PRO LOGIC II surround MUSIC mode. (The PRO LOGIC indicator lights up.)
- 5 **PRO LOGIC** : PRO LOGIC II surround PRO LOGIC mode. (The PRO LOGIC indicator lights up.)
- 6 **STEREO** : Normal stereo playback.

When you select DOLBY DIGITAL

"DOLBY DIGITAL" will be displayed.



When the DTS or DTS-ES (matrix or discrete) signal is input :

- 1 **DTS 5.1ch** : (DTS indicator lights up.)
- 2 **DTS MATRIX** : (DTS MATRIX indicator lights up.)
- 3 **DTS DISCRETE** : (DISCRETE indicator lights up.)
- 4 **STEREO**

When the analog signal or the digital signal (except for DOLBY DIGITAL or DTS signal) is input :

- 1 **PLII MOVIE** : PRO LOGIC II surround MOVIE mode. (The PRO LOGIC indicator lights up.)
- 2 **PLII MUSIC** : PRO LOGIC II surround MUSIC mode. (The PRO LOGIC indicator lights up.)
- 3 **PRO LOGIC** : PRO LOGIC II surround PRO LOGIC mode. (The PRO LOGIC indicator lights up.)
- 4 **NEO: CINEMA** : NEO:6 surround. (The NEO:6 indicator lights up.)
- 5 **NEO: MUSIC** : NEO:6 surround. (The NEO:6 indicator lights up.)
- 6 **CSII CINEMA** : CS 6.1 surround. (The CS II indicator lights up.)
- 7 **CSII MUSIC** : CS 6.1 surround. (The CS II indicator lights up.)
- 8 **CSII MONO** : CS 6.1 surround. (The CS II indicator lights up.)
- 9 **STEREO** : Normal stereo playback. Sound is produced from the two front channels only. (The STEREO indicator lights up.)

- Dolby Digital or DTS signal having more channels than the maximum number of playback channels available using the receiver's current settings is input, downmixing is performed to match the number of available channels.

3 DSP mode (Digital Signal Processor).

DSP can produce these effects without spoiling the sound quality of the original music or video source.

1 Pressing the DSP key or DSP MODE key will display the current DSP MODE status.

2 Each press of the key will switch to the next status as shown below:

- | | | |
|---|------------------|--------------------------------|
| ① | ARENA | : DSP surround ARENA mode. |
| ② | JAZZ CLUB | : DSP surround JAZZ CLUB mode. |
| ③ | THEATER | : DSP surround THEATER mode. |
| ④ | STADIUM | : DSP surround STADIUM mode. |
| ⑤ | DISCO | : DSP surround DISCO mode. |

- The DSP mode selection is displayed for approximately 3 seconds.
- For fine adjustment of the DSP effects, please refer to "Adjusting the sound". → 32

4 Adjust the volume.

Notes

- Depending on the type of the signal or speaker setting, some listening modes cannot be selected.
- When playback is started, the sound may be cut or interrupted before the input source is confirmed as Dolby Digital.
- To enjoy Dolby Digital surround (as well as all the other listening modes) from a single component, be sure to use a Dolby Digital compatible source component.

DVD 6-channel playback

Using a DVD player or the like equipped with six (5.1) output channels and the receiver, you can enjoy surround sound playback.

When you try to play a disc other than Dolby Digital such as DTS CD, no sound is produced or, noise may be heard. To avoid this situation, make sure that you connect the component to the receiver's DVD/6CH INPUT jacks through a surround processor which can decode the surround signal you want to listen to.

Connecting a DVD player which can decode the surround signal itself is also acceptable.

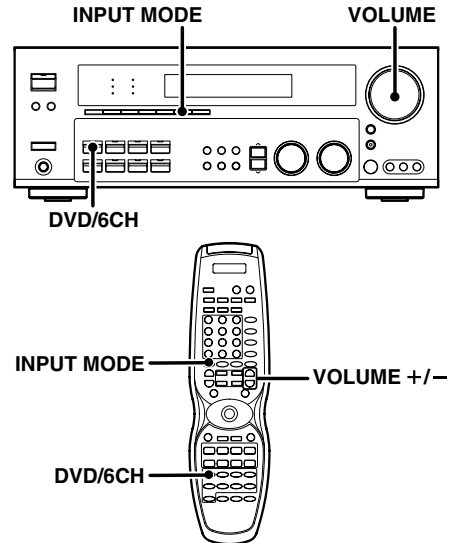

Preparations

- Connect your DVD player to the DVD/6CH jacks of the receiver.
- Turn on all other components that will be used.
- Complete "Preparing for surround sound". → 20

1 Press "DVD/6CH" as the input source.

- If speaker system B is on when "DVD/6CH" is selected as the input source, it switches off and speaker system A turns on automatically.

2 Select "6CH INPUT" by pressing the INPUT MODE key.

3 Start playback of the DVD software.

4 Adjust the volume.

- It is not possible to adjust the volume level or sound quality (**SET UP, SOUND**) of the channels separately when the receiver is in the DVD/6CH mode. Adjust the volume with the controls of the DVD player.
For the powered subwoofer, you can adjust the volume of the subwoofer using the subwoofer's own volume control.

Convenient functions

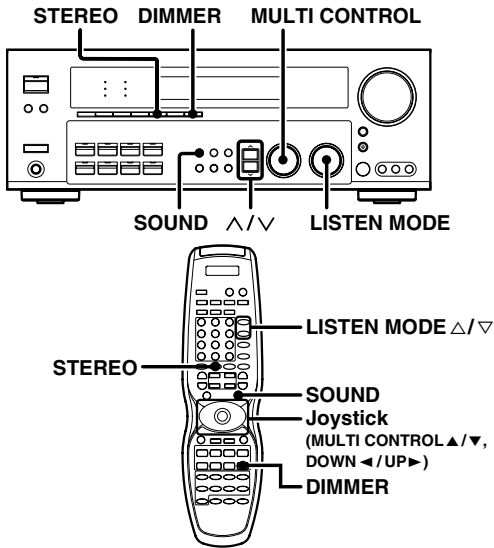

Adjusting the sound

You can make further adjustments to the sound while listening to playback in the surround mode.

- 1 Press the **SOUND** key and then use to the \wedge/\vee keys or joystick (\leftarrow/\rightarrow) until the desired item appears in the display.

Each time you press the \wedge/\vee keys or Joystick (\leftarrow/\rightarrow), the menu changes as follows:

Note that some items are not displayed in certain modes.

- 1 CNTR (Center speaker level adjustment)*
- 2 SR (Right surround speaker level adjustment)*
- 3 SB (Surround back speaker level adjustment)*
- 4 SL (Left surround speaker level adjustment)*
- 5 SUBW (Subwoofer level adjustment)*
- 6 INPUT (Input level adjustment - analog mode only) - 23
- 7 MIDNIGHT (Midnight mode ON/OFF - Dolby Digital mode only)
- 8 PANORAMA (Panorama mode ON/OFF)**
- 9 DIMENSION (Dimension adjustment)**
- 10 CENTER WIDTH (Center width adjustment)**
- 11 CENTER FOCUS (Center focus adjustment)**
- 12 CSII DLY (Rear speaker delay adjustment)**
- 13 CSII GAIN (Input gain adjustment)**
- 14 TruBass (Trubass adjustment)**

- * The adjustment is only temporary for the current input selection. The value will return automatically to the original setup value when the power is turned on/off or when the input selection is changed.
- ** Pro Logic II Music mode only.
- *** CS II mode only.

- 2 Use the **MULTI CONTROL** knob or Joystick ($\blacktriangle/\blacktriangledown$) to adjust the setting as desired.

- The adjustment item is displayed for approximately 8 seconds.

Midnight mode (Dolby Digital mode only)

When watching movies at night, you might not be able to raise the volume as loud as normal. Midnight mode compresses the dynamic range of previously specified parts of the Dolby Digital sound track (like scenes with sudden increases in volume) to minimize the difference in volume between the specified and non-specified parts. This makes it easy to hear all of the sound track, even when listening at low volumes.

- 1 Press the **SOUND** key, then press the \wedge/\vee keys or Joystick (\leftarrow/\rightarrow) until "MIDNIGHT" appears on the display.
 - This can be selected only if CD/DVD, DVD/6CH, VIDEO 2 or VIDEO 3 is selected as the source and the listen mode is set to "DOLBY DIGITAL."

- 2 Use the **MULTI CONTROL** knob or Joystick ($\blacktriangle/\blacktriangledown$) to select the ON or OFF setting.



- The adjustment item is displayed for approximately 8 seconds.
- Some Dolby Digital software may not be compatible with the Midnight mode.

Panorama mode (Pro Logic II Music mode only)

When listening to music, you will be able to enjoy the "wraparound" sound effect when you adjust the panorama mode.

- 1 Press the **SOUND** key, then press the \wedge/\vee keys or Joystick (\leftarrow/\rightarrow) until "PANORAMA" appears on the display.

- 2 Use the **MULTI CONTROL** knob or Joystick ($\blacktriangle/\blacktriangledown$) to select PANORAMA ON or OFF.

- ➔ 1 PANORAMA ON : PANORAMA mode is ON.
- ➔ 2 PANORAMA OFF : PANORAMA mode is OFF.



Dimension mode (Pro Logic II Music mode only)

When listening to music with certain recordings, you will also be able to achieve a suitable balance from all the speakers by adjusting the dimension mode.

- 1 Press the **SOUND** key, then press the \wedge/\vee keys or Joystick (\leftarrow/\rightarrow) until "DIMENSION" appears on the display.

- 2 Use the **MULTI CONTROL** knob or Joystick ($\blacktriangle/\blacktriangledown$) to adjust the soundfield towards the rear or the front.

Soundfield is adjusted towards the front.

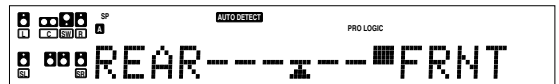

↓
Soundfield is in neutral position.

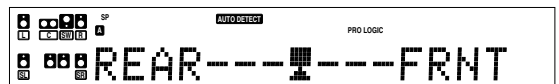

↓
Soundfield is adjusted towards the rear.

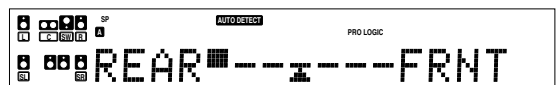

Center Width mode (Pro Logic II Music mode only)

Center width adjustment allows you to enjoy an enhanced sound when listening to music through center image from only center speaker, or left and right speakers or various combinations adjustments.

- 1 Press the **SOUND** key, then press the \wedge/\vee keys or Joystick (\leftarrow/\rightarrow) until "CENTER WIDTH" appears on the display.

- The CENTER WIDTH indication scrolls across the display.
- When the center speaker is switched OFF, this mode will not be effective.

- 2 Use the **MULTI CONTROL** knob or Joystick ($\blacktriangle/\blacktriangledown$) to adjust the left-center-right output.

Ambience effects

Center image will be heard from center speaker only.

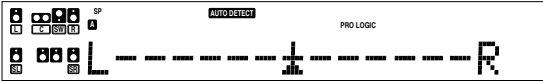

Center image will be heard from left and right speakers only.

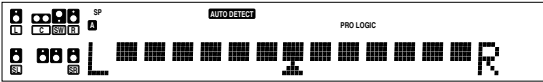

- When in other position, center image from center speaker, left and right speakers can be heard simultaneously with various combinations.

Circle Surround II mode

When you select the circle surround II mode, you will be able to enjoy the multi surround sound from the stereo source.

Use the LISTEN MODE knob or LISTEN MODE ∇/Δ keys for CS II selection.

Center Focus mode (CS II mode only)

Center focus elevate level adjustment allows you to enjoy an enhanced sound when you select CS II CINEMA/MUSIC/MONO. It repositions the sound image to an optimal position more natural to the listener through the center image.

- 1 Press the SOUND key, then press the \wedge/\vee keys or Joystick ($\blacktriangleleft/\blacktriangleright$) until "CENTER FOCUS" appears on the display.

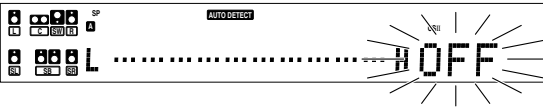

- 2 Use the MULTI CONTROL knob or Joystick ($\blacktriangle/\blacktriangledown$) to adjust the center elevation level.

- The adjustment range is from 0 to 10.

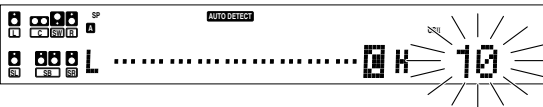

- CENTER FOCUS will not be available when the center speaker is OFF.

CS II Rear Delay adjustment mode (CS II mode only)

CS II Rear Delay adjustment provides a better sound effect from the rear speakers.

- 1 Press the SOUND key, then press the \wedge/\vee keys or Joystick ($\blacktriangleleft/\blacktriangleright$) until "CSII DLY" appears on the display.

- 2 Use the MULTI CONTROL knob or Joystick ($\blacktriangle/\blacktriangledown$) to adjust the rear speaker.

- The adjustment range is from 0 ms to 25 ms.



CS II Gain adjustment mode (CS II mode only)

CS II GAIN allows user to adjust the input gain for the Circle Surround II processing.

- 1 Press the SOUND key, then press the \wedge/\vee keys or Joystick ($\blacktriangleleft/\blacktriangleright$) until "CSII GAIN" appears on the display.

- 2 Use the MULTI CONTROL knob or Joystick ($\blacktriangle/\blacktriangledown$) to adjust the input gain.

- The adjustment range is from 0 to 18.



TruBass adjustment mode (CS II mode only)

TruBass adjustment provides deep, rich bass sound to small speakers without the need of a subwoofer.

- 1 Press the SOUND key, then press the \wedge/\vee keys or Joystick ($\blacktriangleleft/\blacktriangleright$) until "TruBass" appears.

- 2 Use the MULTI CONTROL knob or Joystick ($\blacktriangle/\blacktriangledown$) to select the following;

- ① TruBass OFF
- ② TruBass SW
- ③ TruBass LR
- ④ TruBass SW + LR

- After selecting ②, ③ or ④, TruBass speaker size and level adjustment selection will be available.

- 3 For TruBass speaker selection, use the MULTI CONTROL knob or Joystick ($\blacktriangle/\blacktriangledown$) to select any of the following display;

- ① TruBass LARGE
- ② TruBass MID
- ③ TruBass SMALL

- 4 Use the MULTI CONTROL knob or Joystick ($\blacktriangle/\blacktriangledown$) to adjust the TruBass Level.

- The adjustment range is from 0 (TruBass OFF) to 10.

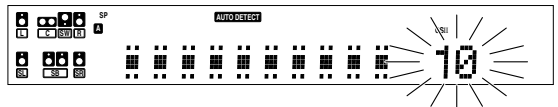

Subwoofer adjustment

It is easy to adjust the volume of the subwoofer using the remote control.

- 1 Press the SOUND key, then press the \wedge/\vee keys or Joystick ($\blacktriangleleft/\blacktriangleright$) until "SUBW" appears on the display.

- 2 Use the MULTI CONTROL knob or Joystick ($\blacktriangle/\blacktriangledown$) to adjust the volume.

- The adjustment range is from -10 dB to +10 dB.

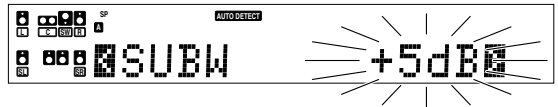

Display dimmer adjustment

The dimmer function lets you select the brightness of the receiver's display. You might find this useful if you darken your room to watch movies or listen to music.

Each time you press the DIMMER key, the display's brightness changes among the three available settings. Select the brightness level you find most pleasing.

- ① Bright
- ② Medium
- ③ Dark

96kHz LPCM playback

The receiver is compatible with the 96kHz LPCM playback. To play a 96kHz DVD, set the listen mode to "STEREO".

- In FULL AUTO input mode the listen mode will automatically be STEREO.
- When in DIGITAL MANUAL input mode (listen mode is not STEREO), "FS 96kHz" will appear in the display and no sound can be heard from the speakers. Press the LISTEN MODE or STEREO key (the listen mode changes to the STEREO mode) to output sound from the speakers.

Basic remote control operations for other components

The remote control supplied with this receiver is also capable of controlling components from a variety of manufacturers once you register the appropriate setup codes into the remote control unit.

Low battery warning

Replace all two batteries with new ones when you notice a shortening of the distance from which the remote control will operate.

For LCD remote control (RC-R0816)

The remote control is designed to retain setup codes in memory while you change batteries.

For non-LCD remote control (RC-R0725)

After changing batteries, please re-enter the setup codes.

Registering setup codes for other components

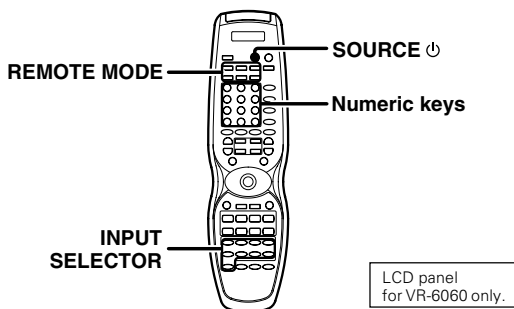

1 Find the setup code of the component to be registered.

- Refer to the setup code lists to find the setup code for the component to be registered. → [36]
- Example: To register a DVD made by KENWOOD, you would enter "805".

Input	Component	Maker	Code	Key
(DVD)	DVD player	KENWOOD	805, 808	DVD

2 Registering components for REMOTE MODE (DVD, CBL, DSS/SAT, VCR, TV, OTHERS) keys.

- For DVD, CBL, DSS/SAT, VCR or TV keys;

Hold down the SOURCE key and press the numeric keys to enter the setup code.

- Example: Press "805" to register a DVD player manufactured by KENWOOD.
- If you push an invalid key, the remote control will display "ERROR" and exit the setup mode.

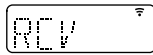
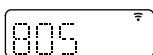

- The OTHERS key enables you to operate another DVD, CBL, DSS/SAT, VCR or TV component.

For OTHERS key;

Hold down the OTHERS key and press the numeric keys to enter the setup code.

- Example: After you have registered the KENWOOD DVD player, press "804" to register another DVD player which is manufactured by Panasonic.
- If you push an invalid key, the remote control will display "ERROR" and exit the setup mode.

3 Press any of the REMOTE MODE key and then press the SOURCE key to check that the component you want to control turns on.

If the component does not react, and there is more than one setup code, enter another setup code and try again.

- If the component is already on, pressing the SOURCE key will turn it off.

4 Repeat steps 2 to 3 to register additional components until all components have been registered.

Alternative REMOTE MODE key.

This operation is optional and is convenient when you link an INPUT SELECTOR key to the REMOTE MODE key. While operating one component, the INPUT SELECTOR key functions as an alternative REMOTE MODE key to select another component.

- Example: REMOTE MODE (DVD) key can be linked to the INPUT SELECTOR (VIDEO 1) key as described below;

1 After registering the setup code, press and hold the SOURCE key and then press the REMOTE MODE (DVD) key.

2 While holding down SOURCE key press the INPUT SELECTOR (VIDEO 1) key.

- Now the VIDEO 1 key will function as a DVD key which can be selected at the same time while operating a CD player.
- Repeat step 1 to 2 to link other INPUT SELECTOR keys.

Note

Although each setup code is designed to work with a number of different models, certain codes may not work with some models. (Also, certain codes may only operate some of the functions available on a given model.)

Operating other components

This operation lets you operate the registered components. KENWOOD audio components with system control turn on and off automatically with the receiver via the system control connections.

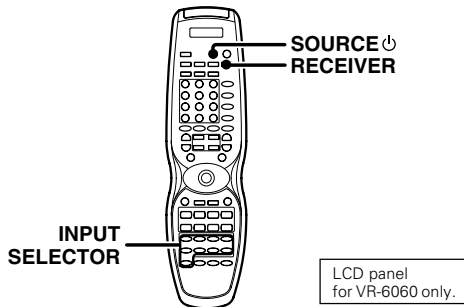

1 Use the INPUT SELECTOR keys to select the component you desire.

- Pressing the INPUT SELECTOR keys also changes the input selector on the receiver.
- When you operate your registered DVD player, Cable tuner, DSS/SAT receiver, VCR or TV, go to step 2.
- When you operate the CD player, Cassette deck, MD player, or Tuner with system control connection, go to step 2.

2 Press the SOURCE ϕ key.

- To return to the receiver operation mode, press the RECEIVER key.

3 Press the operation keys you desire.

- 38

The remote control mode remains at the selected input. If you wish to operate another component, repeat step 2 or 3.

Note

Be sure to point the remote control at the remote sensor on the receiver when you want to operate KENWOOD components connected by system control cords. Otherwise, point the remote control at the component you want to operate.

Storing the remote control code of the other components (For VR-6060 only)

The remote control unit can store the remote control code of the other components and you can operate the other components from the remote control unit. The remote control code is stored on the key or memory of the remote control unit.

Storing on the key

You can store the remote control code to the key as shown below:

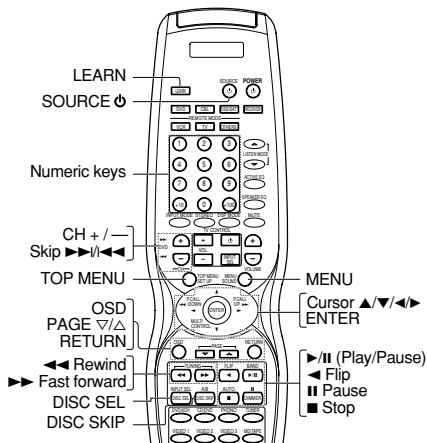

1 Point the infrared ray system part of another remote control unit to the remote sensor of the remote control unit.

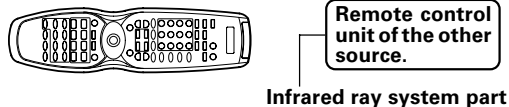

2 Press the LEARN key.

- This remote control is ready to receive the remote control code from the other source.

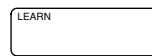

3 Press any of the REMOTE MODE (DVD, CBL, DSS/SAT, VCR, TV, OTHERS) keys to select the input of the desired remote control unit.

4 Press the desired key of the remote control unit.



5 From the remote control unit of the other source, press the key that you want to store.

- The remote control code is sent to the remote control unit.
- "OK" appears when finished.

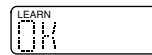

- When the appropriate code is not properly stored, "AGAIN" will be displayed. Repeat from step 2 onwards.



- If the code cannot be stored after a few attempts, "ERROR" will appear. Repeat from step 2 onwards.
- If LEARN mode's storage is full, "FULL" appears on the display.

6 The remote control code is stored on the key of this remote control unit.

7 Press the LEARN key again to exit the learning mode.

Setup code chart (RC-R0816) (VR-6060) and (RC-R0725) (KRF-V8060D)

TV Setup codes

Maker	Setup codes
AKAI	125
BELL+HOWELL	142
CENTURION	126
CORONAD	127
DAEWOO	136, 140, 141, 145
EMERSON	130, 131, 132, 133, 146
FISHER	119
G.E.	102, 122, 129
GOLD STAR	137, 148
HITACHI	114, 115
JVC	113
KTV	138, 139
LOEWE	123, 124
MAGNAVOX	109, 147
MARANTZ	121
MITSUBISHI	121
PANASONIC	111, 112, 122, 129
PHILIPS	109, 147
PIONEER	116
PROSCAN	117
RADIOSHACK	128
RCA	102, 103, 104, 105, 106, 126
SAMSUNG	134, 135
SANYO	119
SEARS	120
SHARP	110
SONY	101
SYMPHONIC	143, 144
TOSHIBA	120
QUASAR	111, 118
ZENITH	107, 108

CBL codes

Maker	Setup codes
GEMINI	218
G.I.	209
HAMLIN	210, 211, 234, 235
JERROLD	201, 202, 224, 225, 226, 227, 228, 229, 233
MACOM	215, 216, 217
MAGNAVOX	236
OAK	212, 213, 214
PANASONIC	221, 222, 232
PHILIPS	219, 220, 237, 238, 239, 240
PIONEER	206, 207
SAMSUNG	223
S. ATLANTA	203, 230, 231
TOCOM	208
ZENITH	204, 205

VCR Setup codes

Maker	Setup codes
AIWA	352
AKAI	354, 355, 356
BELL+HOWELL	351
DAEWOO	349
EMERSON	334, 335, 336, 337, 338
FISHER	330, 341, 342, 343
G.E.	307, 321
GOLD STAR	323
GO_VIDEO	347, 348, 353
HITACHI	307, 308, 328, 329
JVC	324, 325, 326, 327
MAGNAVOX	311, 312, 313
MITSUBISHI	315, 316, 317, 318, 357, 358
NEC	344, 345
ORION	335
PANASONIC	309, 310
PHILIPS	313
QUASAR	309, 310, 311, 312
RCA	308
SAMSUNG	332, 339, 340
SANYO	351
SCOTT	331
SHARP	319, 320
SHINTOM	333
SONY	301, 302, 303, 304, 305, 306
SYNPHO	346
TEKNICA	346, 350
TOSHIBA	314
ZENITH	322

DVD player Setup codes

Maker	Setup codes
HITACHI	812
JVC	801
KENWOOD	805, 808
MITSUBISHI	810
ONKYO	815, 816
PANASONIC	804
PHILIPS	807
PIONEER	803
PROSCAN	811
RCA	811
SAMSUNG	814
SONY	802
TOSHIBA	806
YAMAHA	809
ZENITH	806, 813

DSS/SAT codes

Maker	Setup codes
EHOSTAR	903
G.I.	902
HITACHI	908
HUGHES	906
PANASONIC	905
PRIMESTAR	909
RCA	901
SONY	907
TOSHIBA	904

CASSETTE deck, CD player & MD recorder operations

You can perform these basic operations using the keys described below when connected to KENWOOD cassette deck, CD player or MD recorder equipped with system control operations.

The LCD panel is only for remote control RC-R0816 (VR-6060 model).

Cassette deck operations keys

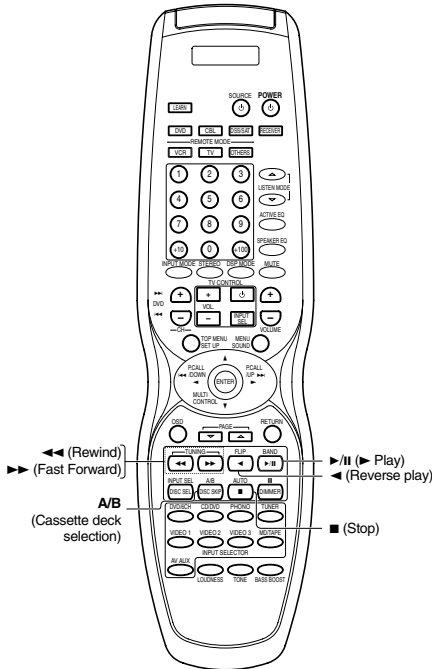

RC-R0816/R0725

CD player operation keys

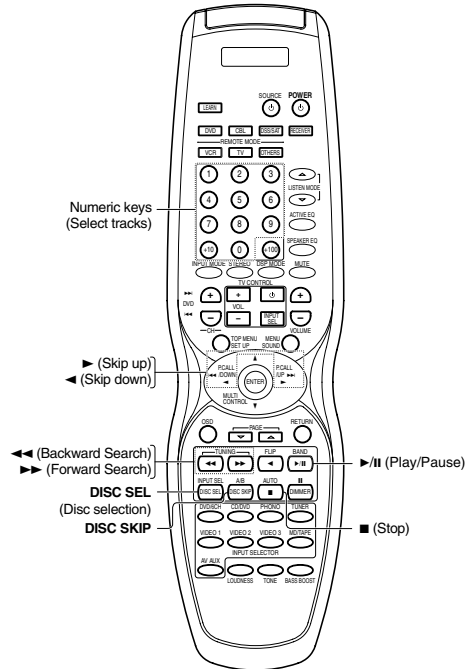

RC-R0816/R0725

MD recorder operation keys

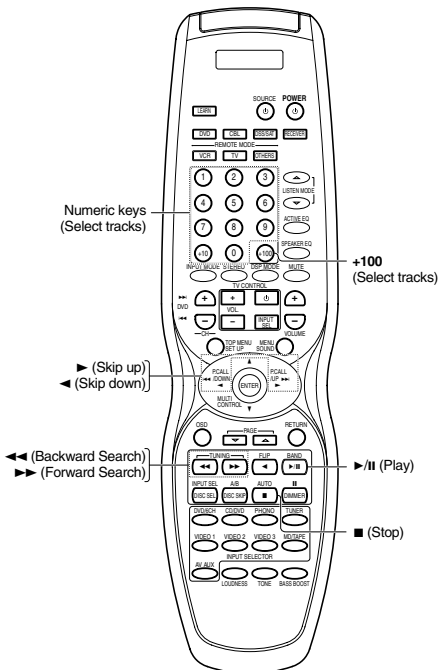

RC-R0816/R0725

Other components' operations

Refer to the following for the type of remote control operations available for each component.

- ❶ Select the input source.
- ❷ Press the keys corresponding to the operations you desire. Refer to the following sections for details.

- When pressing keys in succession, press each key firmly and be sure to wait at least 1 second before pressing the next key.
- Numeric keys function the same as the numeric keys on the original remote.

These keys can be used to perform the basic operations of KENWOOD and other manufacturers' components which the setup code for each component had been entered beforehand.
The LCD panel is only for remote control RC-R0816 (VR-6060 model). - 36

TV operation keys

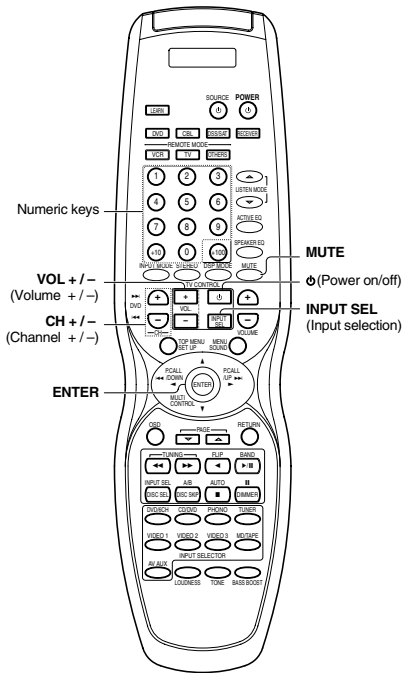

RC-R0816/R0725

VCR operation keys

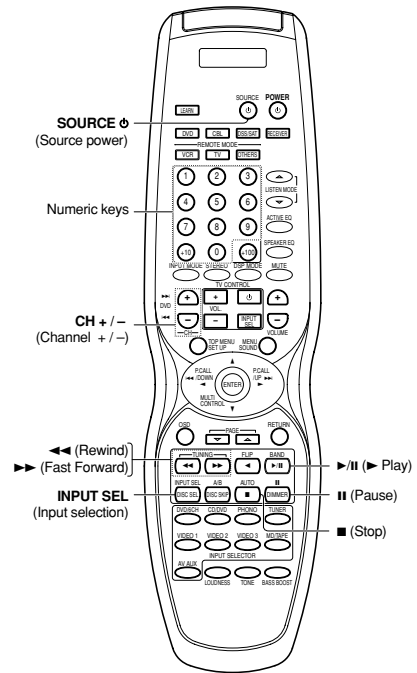

RC-R0816/R0725

DSS/SAT receiver operation keys

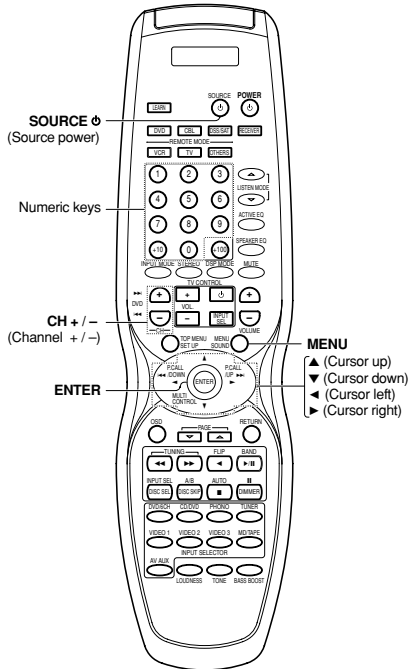

RC-R0816/R0725

Cable tuner operation keys

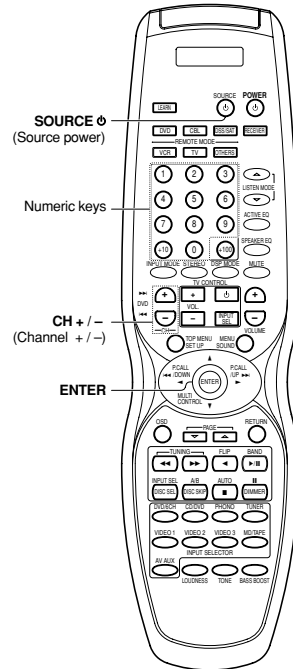

RC-R0816/R0725

DVD player operation keys

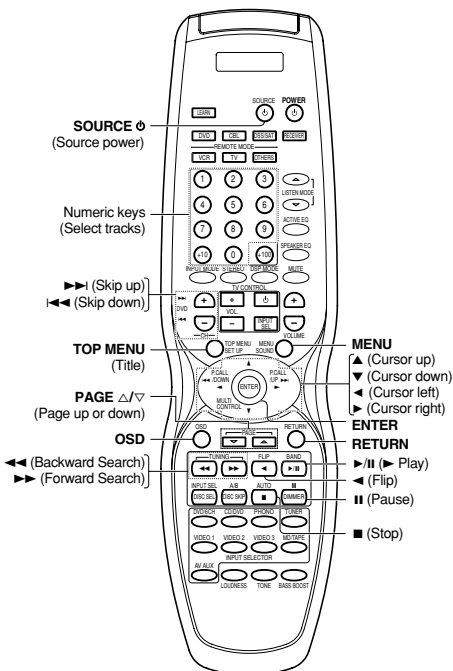

RC-R0816/R0725

In case of difficulty

Resetting the Microcomputer

The microcomputer may malfunction (unit cannot be operated, or shows an erroneous display) if the power cord is unplugged while the power is ON, or due to some other external factor. If this happens, execute the following procedure to reset the microcomputer and return the unit to its normal operating condition.

- Please note that resetting the microcomputer will clear the contents of the memory and returns the unit to the state it was in when it left the factory.

For the U.S.A. and Canada

Unplug the power cord from the wall outlet, then plug it back in while holding down the POWER ON/STANDBY ϕ key.

For other countries

With the power cord plugged in, turn the POWER ON/OFF key OFF. Then, while holding down the ON/STANDBY ϕ key, press POWER ON/OFF.

Amplifier

Symptom	Cause	Remedy
No sound from the speakers.	<ul style="list-style-type: none"> • The speaker cords are disconnected. • VOLUME is set to the minimum position. • MUTE is ON. • The SPEAKERS switches are set to OFF. 	<ul style="list-style-type: none"> • Connect them properly referring to "Connecting the speakers" - [14] • Adjust the volume to a proper level. • Turn OFF the MUTE. - [24] • Set the SPEAKERS switches to ON. - [22]
The standby indicator blinks and sound is not output.	<ul style="list-style-type: none"> • Speaker cords are short-circuited. 	<ul style="list-style-type: none"> • Turn the power off, eliminate the short-circuiting, then turn on the power again.
Sound is not output from one of the speakers.	<ul style="list-style-type: none"> • The speaker cord is disconnected. 	<ul style="list-style-type: none"> • Connect it properly referring to "Connecting the speakers". - [14]
Sound is not output from the surround speakers and / or the center speaker, or their sound is very small.	<ul style="list-style-type: none"> • The surround speaker cords and/or the center speaker cord is disconnected. • A surround mode has not been engaged. • The surround and/or center volume controls are set to the minimum level. 	<ul style="list-style-type: none"> • Connect it properly referring to "Connecting the speakers". - [14] • Select a surround mode. • Adjust the speaker levels using the test tone. - [21]
A humming noise is generated when the PHONO input selector is selected.	<ul style="list-style-type: none"> • The audio cord from the record player is not connected to the PHONO jacks. • The record player is not grounded. 	<ul style="list-style-type: none"> • Insert the audio cord plugs securely into the PHONO jacks. • Connect the grounding wire to the GND terminal on the rear panel.
When playing a Dolby Digital source signal using a DVD player, the sound is cut off soon after it starts.	<ul style="list-style-type: none"> • There are many possible causes for this problem, depending on the type of DVD player used. 	<ul style="list-style-type: none"> • Set the input mode to digital manual before starting playback of the Dolby Digital source. - [8]
No sound is produced during playback from a DVD player.	<ul style="list-style-type: none"> • The input mode is set to digital manual. 	<ul style="list-style-type: none"> • Press the INPUT MODE key to select to full auto mode. - [8]
A video source cannot be recorded normally.	<ul style="list-style-type: none"> • The software is copy-guarded. 	<ul style="list-style-type: none"> • Copy-guarded video software cannot be recorded.

Tuner

Symptom	Cause	Remedy
Radio stations cannot be received.	<ul style="list-style-type: none"> • No antenna is connected. • The broadcast band is not set properly. • The frequency of the desired station is not tuned. 	<ul style="list-style-type: none"> • Connect an antenna. - [16] • Set the broadcast band properly. • Tune the frequency of the desired station. - [26]
Interference.	<ul style="list-style-type: none"> • Noise due to ignition noise from an automobile. • Noise due to interference from an electric appliance. • Noise due to a nearby TV set. 	<ul style="list-style-type: none"> • Install the outdoor antenna away from the road. • Turn off the power to the appliance. • Install the receiver farther away from the TV.
A station which was preset cannot be received by pressing the corresponding numeric key.	<ul style="list-style-type: none"> • The preset station belongs to a frequency that cannot be received. • The preset memory was cleared because the power cord had been unplugged for a long period of time. 	<ul style="list-style-type: none"> • Preset a station with a receivable frequency. • Preset the station again.

Remote control unit

Symptom	Cause	Remedy
<p>Certain inputs cannot be selected using the remote control.</p>	<ul style="list-style-type: none"> • No setup codes registered for the respective input(s). 	<ul style="list-style-type: none"> • Register a setup code at the respective input(s). → [36]
<p>Remote control operation is not possible.</p>	<ul style="list-style-type: none"> • The remote control is set to a different operation mode. • Batteries are exhausted. • The remote control unit is too far away from the main system, controlling angle is too large, or there is an obstacle between the receiver and the remote. • The audio cords and system control cords are not connected properly. • No software is loaded in the source component. • An attempt is made to play a tape which is being recorded in the cassette deck. • The remote control has not been set to the operation mode for the component you wish to control. 	<ul style="list-style-type: none"> • Press the source select keys or SOURCE ϕ keys to select the appropriate operation mode. • Replace with new batteries. • Operate the remote control unit within the controllable range. • Connect properly referring to "Setting up the system". • Place software in the source component you want to play. • Wait until recording has completed. • Press the source select keys or SOURCE ϕ key to activate the operation mode for the component you want to control before operation. → [35]

For the U.S.A and Canada

AUDIO section (VR-6060)

Rated power output during STEREO operation

100 watts per channel minimum RMS, both channels driven, at 8 Ω from 20 Hz to 20 kHz with no more than 0.09% total harmonic distortion. (FTC)

Effective power output during SURROUND operation

FRONT (20 ~ 20 kHz, 0.09 % T.H.D. at 8 Ω one channel driven)	100 W + 100 W
CENTER (20 ~ 20 kHz, 0.09 % T.H.D. at 8 Ω one channel driven)	100 W + 100 W
SURROUND (20 ~ 20 kHz, 0.7 % T.H.D. at 8 Ω one channel driven)	100 W + 100 W
SURROUND BACK/SUBWOOFER (20 ~ 20 kHz, 0.09 % T.H.D. at 8 Ω one channel driven)	100 W
Total harmonic distortion	0.009 % (1 kHz, 50 W, 8 Ω)
Frequency response	
Line (CD/DVD, TAPE, VIDEO 1, VIDEO 2, VIDEO 3, DVD/6CH)	10 Hz ~ 100 kHz, +0 dB ~ -3.0 dB
PHONO 'RIAA' response	40 Hz ~ 20 kHz, +1.5 dB ~ -3.0 dB
Maximum input level	
PHONO (MM)	45 mV, 1 % T.H.D. at 1 kHz
Signal to noise ratio (IHF'66)	
PHONO (MM)	75 dB
Line (CD/DVD, TAPE, VIDEO 1, VIDEO 2, VIDEO 3, DVD/6CH)	95 dB
Loudness control	
VOLUME at -30 dB level	+6 dB (100 Hz)
Input sensitivity / impedance	
PHONO (MM)	6.0 mV / 47 kΩ
Line (CD/DVD, TAPE, VIDEO 1, VIDEO 2, VIDEO 3, DVD/6CH)	500 mV / 47 kΩ
Output level / impedance	
TAPE REC	500 mV / 1 kΩ
PRE OUT (SURROUND BACK CHANNEL)	2.5 V / 1 kΩ
PRE OUT (SUBWOOFER)	2.5 V / 1 kΩ
Tone control	
BASS	±10 dB (at 100 Hz)
TREBLE	±10 dB (at 10 kHz)

For other countries

AUDIO section (KRF-V8060D)

Effective power output during STEREO operation

1 kHz, 10 %, 8 Ω 110 W + 110 W

Rated power output during STEREO operation

100 watts per channel minimum RMS, both channels driven, at 8 Ω from 20 Hz to 20 kHz with no more than 0.09% total harmonic distortion. (FTC)

Effective power output during SURROUND operation

FRONT (1 kHz, 10% T.H.D. at 8 Ω one channel driven)	110 W + 110 W
CENTER (1 kHz, 10% T.H.D. at 8 Ω one channel driven)	110 W
SURROUND (1 kHz, 10% T.H.D. at 8 Ω one channel driven)	110 W + 110 W
SURROUND BACK/SUBWOOFER (1 kHz, 10% T.H.D. at 8 Ω one channel driven)	110 W
Total harmonic distortion	0.009% (1 kHz, 50 W, 8 Ω)
Frequency response	
Line (CD/DVD, TAPE, VIDEO 1, VIDEO 2, VIDEO 3, DVD/6CH)	10 Hz ~ 100 kHz, +0 dB ~ -3.0 dB
PHONO 'RIAA' response	40 Hz ~ 20 kHz, 1.5 dB ~ -3.0 dB
Maximum input level	
PHONO (MM)	45 mV, 1 % T.H.D. at 1 kHz
Signal to noise ratio (IHF'66)	
PHONO (MM)	75 dB
Line (CD/DVD, TAPE, VIDEO 1, VIDEO 2, VIDEO 3, DVD/6CH)	95 dB
Loudness control	
VOLUME at -30 dB level	+6 dB (100 Hz)
Input sensitivity / impedance	
PHONO (MM)	6.0 mV / 47 kΩ
Line (CD/DVD, TAPE, VIDEO 1, VIDEO 2, VIDEO 3, DVD/6CH)	500 mV / 47 kΩ
Output level / impedance	
TAPE REC	500 mV / 1 kΩ
PRE OUT (SURROUND BACK CHANNEL)	2.5 V / 1 kΩ
PRE OUT (SUBWOOFER)	2.5 V / 1 kΩ
Tone control	
BASS	±10 dB (at 100 Hz)
TREBLE	±10 dB (at 10 kHz)

Specifications

DIGITAL AUDIO section

Sampling frequency	32 kHz, 44.1 kHz, 48 kHz, 96 kHz
Input level / impedance / wave length	
Optical	(-15 dBm ~ -24 dBm), 660 nm \pm 30 nm
Coaxial	0.5 Vp-p / 75 Ω

VIDEO section

VIDEO inputs / outputs	
VIDEO (composite)	1 Vp-p / 75 Ω
S VIDEO inputs / outputs	
S VIDEO (luminance signal)	1 Vp-p / 75 Ω
S VIDEO (chrominance signal)	0.286 Vp-p / 75 Ω
COMPONENT VIDEO inputs / outputs	
COMPONENT VIDEO (luminance signal)	1 Vp-p / 75 Ω
COMPONENT VIDEO (CB/CR-signal)	\pm 0.32 Vp-p / 75 Ω

FM tuner section

Tuning frequency range	87.5 MHz ~ 108.0 MHz
Usable sensitivity (MONO)	
VR-6060	1.3 μ V (75 Ω) / 13.2 dBf (75 kHz dev, SINAD 30 dB)
KRF-V8060D	1.6 μ V (75 Ω) / 15.2 dBf (75 kHz dev, SINAD 30 dB)
50 dB quieting sensitivity	
STEREO	28 μ V (75 Ω) / 40.2 dBf
Total harmonic distortion	
MONO (1 kHz, 75 kHz dev)	0.5% (65 dBf input)
STEREO (1 kHz, 67.5 + 6.75 kHz dev)	0.7% (65 dBf input)
Signal to noise ratio	
MONO (1 kHz, 75 kHz dev)	75 dB (65 dBf input)
STEREO (1 kHz, 67.5 + 6.75 kHz dev)	68 dB (65 dBf input)
Stereo separation (1 kHz)	40 dB
Selectivity (\pm 400 kHz) (VR-6060)	70 dB
(KRF-V8060D)	50 dB
Frequency response (30 Hz ~ 15 kHz)	+0.5 dB, -3.0 dB

AM tuner section

Tuning frequency range	
10 kHz step	530 kHz ~ 1,700 kHz (VR-6060)
10 kHz step	530 kHz ~ 1,610 kHz (KRF-V8060D)
9 kHz step	531 kHz ~ 1,602 kHz (KRF-V8060D)
Usable sensitivity (30% mod, S/N 20 dB)	
	16 μ V / (600 μ V/m)
Signal to noise ratio (30% mod, 400 Hz)	
	50 dB (60 dB μ VEMF input)

GENERAL

Power consumption VR-6060	3 A
KRF-V8060D	300 W
AC outlet	
SWITCHED VR-6060	(total 150 W, 1.25 A max.)
KRF-V8060D	(total 90 W max.)
Dimensions	W : 440 mm (17-5/16")
	H : 159 mm (6-1/4")
	D : 392 mm (15-7/16")
Weight (Net)	
VR-6060	9.4 kg (20.7 lb)
KRF-V8060D	10.0 kg (22.0 lb)

Notes

1. KENWOOD follows a policy of continuous advancements in development. For this reason specifications may be changed without notice.
2. The full performance may not be exhibited in an extremely cold location (under a water-freezing temperature).

KENWOOD

For your records

Record the serial number, found on the back of the unit, in the spaces designated on the warranty card, and in the space provided below. Refer to the model and serial numbers whenever you call upon your dealer for information or service on this product.

Model _____ Serial Number _____